

Panasonic®

the Genius 1100

Operating Instructions

**Microwave Oven
Model NN-S688/NN-S588**

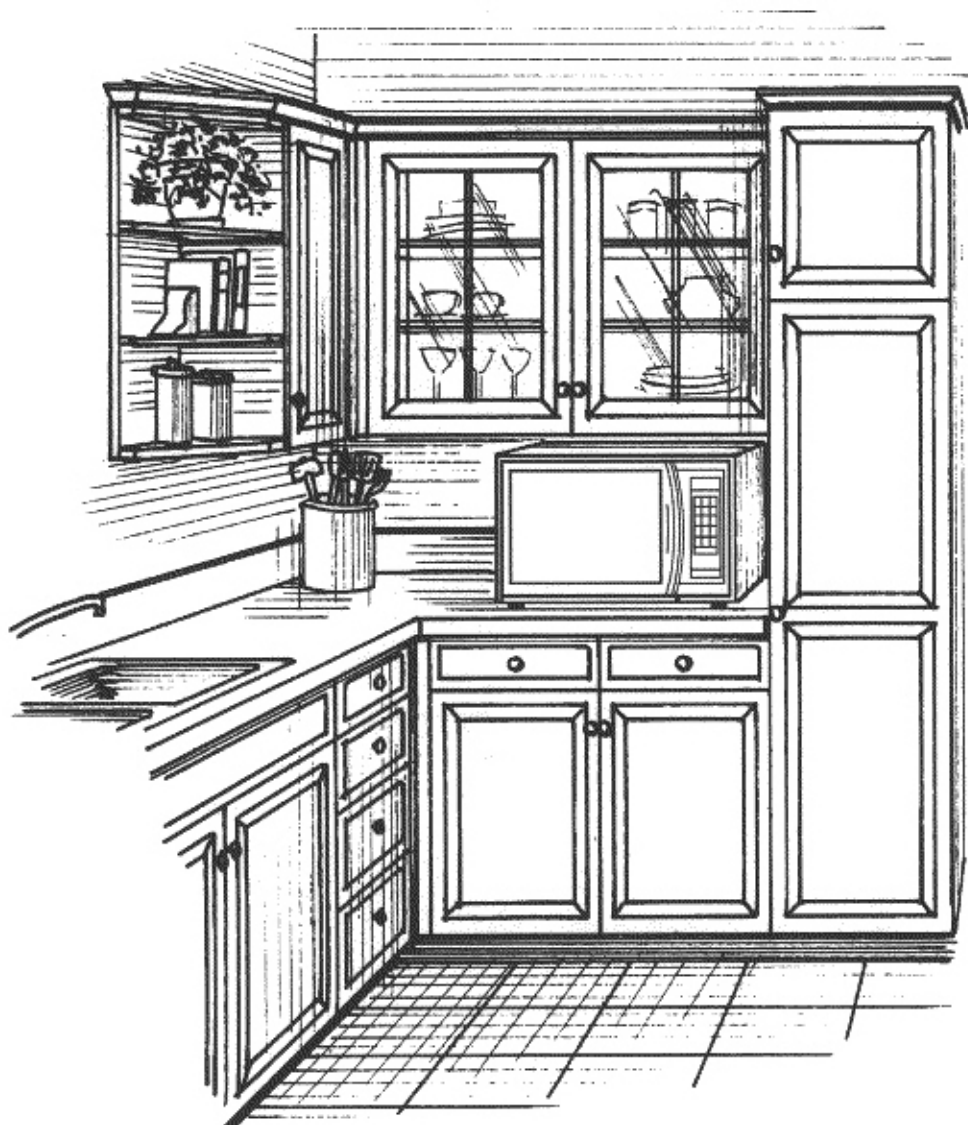

Before operating this oven, please read these instructions completely.
Antes de operar este producto, lea este instructivo en su totalidad.
El manual de instrucciones en español puede ser encontrada en la páginas 35-53.
(Spanish Operating Instructions can be found on pages 35-53.)
Parts order information on page 33.

Thank you for purchasing the Panasonic Microwave Oven.

PRECAUTIONS TO AVOID POSSIBLE EXPOSURE TO EXCESSIVE MICROWAVE ENERGY

- (a) Do not attempt to operate this oven with the door open since open-door operation can result in harmful exposure to microwave energy. It is important not to defeat or tamper with the safety interlocks.
- (b) Do not place any object between the oven front face and the door, or allow soil or cleaner residue to accumulate on sealing surfaces.
- (c) Do not operate the oven if it is damaged. It is particularly important that the oven door close properly and that there is no damage to the:
 - (1) door (bent)
 - (2) hinges and latches (broken or loosened)
 - (3) door seals and sealing surfaces.
- (d) The oven should not be adjusted or repaired by anyone except properly qualified service personnel.

STAPLE YOUR STORE RECEIPT HERE.

Technical Specifications

	NN-S688 1.3 cu. ft.	NN-S588 1.0 cu. ft.
Power Consumption:	14.0 Amps, 1600 W	14.0 Amps, 1600 W
Output:	1100 W	1100 W
Outside Dimensions (H x W x D):	12" x 21 ⁷ / ₈ " x 16 ³ / ₄ " (306 x 555 x 425mm)	12" x 20" x 14 ³ / ₁₆ " (306 x 510 x 360mm)
Oven Cavity Dimensions: (H x W x D):	9 ¹ / ₈ " x 14 ¹⁵ / ₁₆ " x 15 ¹³ / ₁₆ " (232 x 380 x 402mm)	9" x 13 ⁷ / ₈ " x 13 ⁵ / ₁₆ " (229 x 353 x 338mm)
Operating Frequency:	2,450 MHz	2,450 MHz
Uncrated Weight:	38 lbs. (17.2 kg)	34 lbs. (15.3 kg)

The serial number of this product may be found on the right side of the oven door opening. You should note the model number and the serial number of this oven in the space provided and retain this book as a permanent record of your purchase for future reference.

Model No. _____

Serial No. _____

Date of Purchase _____

CONTENTS

Before Operating

Safety Instructions	2
Installation Instructions	3
Grounding Instructions	3
Safety Precautions	4
Cookware and Utensil Guide	5
Feature Diagram	6
Control Panel	7

Operation & Hints

Let's Start to Use Your Oven!	8
To Use Function Pad	8 - 9
To Set Clock	10
To Reheat using	
Power and Time Setting	10
Sensor Reheat Pad	16
To Defrost using	
Power and Time Setting	10
Turbo Defrost Pad	12
To Cook using	
Power and Time Setting	10
Sensor Cook Pads	16 - 18
World Gourmet Cooking	18 - 21
To Use Popcorn Pad	14
To Set Timer (Stand Time/Delay Start)	11
To Use Quick Minute	14

Cooking Guide & Charts

Defrosting Tips and Techniques	13
Microwave Shortcuts	15
World Gourmet Recipes	19 - 21
Food Characteristics	22
Cooking Techniques	22 - 23
Cooking Charts	
Meats	24 - 25
Poultry	26
Fish and Seafood	27
Vegetables	28
Pasta, Rice and Cereal	29
Quick Breads and Cakes	30
Eggs and Cheese	31
Pies	31

Maintenance

Before Requesting Service	32
Parts Order Information	33
Care of Your Microwave Oven	33
Technical Specifications	Inside Front Cover
Quick Guide to Operation	Back Cover

Manual de instrucciones (Spanish Operating Instructions)

Precauciones	35
Instrucciones de Seguridad	35 - 36
Instrucciones para Conexión a Tierra	36
Instrucciones de Instalación	37
Sugerencias Útiles	38
Diagrama de Características	39
Panel de Controles	39
Procedimientos de Operación	40 - 51
Cuidados de Su Horno de Microondas	53
Antes de Acudir a Servicio	53

IMPORTANT SAFETY INSTRUCTIONS

Your microwave oven is a cooking device and you should use as much care as you use with a stove or any other cooking device. When using this electric appliance, basic safety precautions should be followed, including the following:

WARNING—To reduce the risk of burns, electric shock, fire, injury to persons or exposure to excessive microwave energy:

1. Read all instructions before using the appliance.
2. Read and follow the specific **"PRECAUTIONS TO AVOID POSSIBLE EXPOSURE TO EXCESSIVE MICROWAVE ENERGY,"** found on back of the front cover.
3. This appliance must be grounded. Connect only to properly grounded outlet. See **"GROUNDING INSTRUCTIONS"** found on page 3.
4. Install or locate this appliance only in accordance with the installation instructions found on page 3.
5. Do not cover or block any openings on this appliance.
6. Do not store or use this appliance outdoors.
Do not use this product near water—for example, near a kitchen sink, in a wet basement, or near a swimming pool, and the like.
7. Use this appliance only for its intended use as described in this manual. Do not use corrosive chemicals or vapors in this appliance. This type of oven is specifically designed to heat or cook. It is not designed for industrial or laboratory use.
8. When cleaning surfaces of door and oven that come together on closing the door, use only mild, non-abrasive soaps or detergents applied with a sponge or soft cloth.
9. As with any appliance, **close supervision is necessary** when used by children.
10. Do not operate this appliance if it has a damaged cord or plug, if it is not working properly, or if it has been damaged or dropped.
11. Do not immerse cord or plug in water.
12. Keep cord away from heated surfaces.
13. Do not let cord hang over edge of table or counter.
14. This appliance should be serviced only by qualified service personnel. Contact the nearest authorized service facility for examination, repair or adjustment.
15. Some products such as whole eggs and sealed containers—for example, closed glass jars—may explode and should not be heated in this oven.
16. To reduce the risk of fire in the oven cavity:
 - (a) Do not overcook food. Carefully attend appliance if paper, plastic, or other combustible materials are placed inside the oven to facilitate cooking.
 - (b) Remove wire twist-ties from paper or plastic bags before placing bag in oven.
 - (c) If materials inside the oven should ignite, keep oven door closed, turn oven off, and disconnect the power cord, or shut off power at the fuse or circuit breaker panel.

- (d) Do not use the cavity for storage purposes.
Do not leave paper products, cooking utensils, or food in the cavity when not in use.

General Use

1. **DO NOT** tamper with or make any adjustments or repairs to door, control panel housing, safety interlock switches or any other part of the oven. **DO NOT** remove outer panel from oven. Repairs should only be done by a qualified service person.

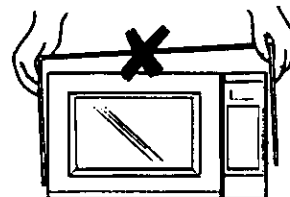

2. **DO NOT** operate the oven empty. The microwave energy will reflect continuously throughout the oven if food or water is not present to absorb energy. This could damage the oven and result in the danger of a fire.

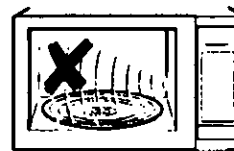

3. **DO NOT** use this oven to heat chemicals or any other non-food products. **DO NOT** clean this oven with any product that is labeled as containing corrosive chemicals. **The heating of corrosive chemicals in this oven can cause radiation leaks.**
4. **DO NOT** dry clothes, newspapers or other materials in oven. They may catch fire.
5. **DO NOT** use recycled paper products unless the paper product is labeled as safe for microwave oven use. Recycled paper products may contain impurities which may cause sparks and/or fires when used.
6. **DO NOT** use newspapers or paper bags for cooking. Fire can result.
7. **DO NOT** hit or strike control panel. Damage to controls may occur. Fire can result.
8. **POT HOLDERS** should always be used when removing items from the oven. Heat is transferred from the **HOT** food to the cooking container and from the cooking container to the Glass Tray. Glass Tray can be very **HOT** after removing cooking container from oven.
9. **DO NOT** store flammable materials next to, on top of, or in the oven. These could be fire hazards.

SAVE THESE INSTRUCTIONS

For proper use of your oven read remaining safety cautions and operating instructions.

INSTALLATION & GROUNDING INSTRUCTIONS

Examine Your Oven

Unpack oven, remove all packing material, and examine the oven for any damage such as dents, broken door latches or cracks in the door. Notify dealer immediately if oven is damaged. **Do NOT** install if oven is damaged.

Placement of Oven

- Oven must be placed on a flat, stable surface. For proper operation, the oven must have sufficient air flow. Allow 3 inches (8 cm) of space on both sides of the oven and 1 inch (2.5 cm) of space on top of oven.
 - Do NOT** block air vents.
If they are blocked during operation, the oven may overheat. If the oven overheats, a thermal safety device will turn the oven off. The oven will remain inoperable until it has cooled.
 - Do NOT** place oven near a hot damp surface such as a gas or electric range.
 - Do NOT** operate oven when room humidity is too high.
- This oven was manufactured for household use only.

Grounding Instructions

This appliance must be grounded. In the event of an electrical short circuit, grounding reduces the risk of electric shock by providing an escape wire for the electric current. This appliance is equipped with a cord having a grounding wire with a grounding plug. The plug must be plugged into an outlet that is properly installed and grounded.

WARNING—Improper use of the grounding plug can result in a risk of electric shock.



Consult a qualified electrician or service person if the grounding instructions are not completely understood, or if doubt exists as to whether the appliance is properly grounded.

If it is necessary to use an extension cord, use only a three wire extension cord that has a three blade grounding plug, and a three slot receptacle that will accept the plug on the appliance. The marked rating of the extension cord should be equal to or greater than the electrical rating of the appliance.

Power Supply

- A short power-supply cord is provided to reduce the risks resulting from becoming entangled in or tripping over a longer cord.
- Longer cord sets or extension cords are available and may be used if care is exercised in their use.
- If a long cord or extension cord is used, (1) the marked electrical rating of the cord set or extension cord should be at least as great as the electrical rating of the appliance, (2) the extension cord must be a grounding-type 3-wire cord, and (3) the longer cord should be arranged so that it will not drape over the countertop or tabletop where it can be pulled on by children or tripped over accidentally.

Wiring Requirements

- The oven must be on a **SEPARATE CIRCUIT**. No other appliance should share the circuit with the microwave oven. If it does, the branch circuit fuse may blow, or the circuit breaker may trip or the food may cook slower than the times recommended in this manual.
- The **VOLTAGE** used must be the same as specified on this microwave oven (120V). Using a higher voltage is dangerous and may result in a fire or other accident causing oven damage. Using a lower voltage will cause slow cooking. Panasonic is **NOT** responsible for damage resulting from the use of the oven with other than specified voltage.
- The oven must be plugged into at least a **20 AMP 120 VOLT, 60 Hz GROUNDED OUTLET**.
Where a standard two-prong outlet is encountered, it is the personal responsibility and obligation of the consumer to have it replaced with a properly grounded three-prong outlet.
- A **TEMPORARY CONNECTION** with a two-prong adapter may be made where **LOCAL CODES PERMIT**. Unless the cover screw is grounded through the house wiring, attaching the adapter grounding plate to the cover screw will not ground the oven. If there is any doubt that the cover screw is grounded, have it checked by an electrician.

Radio Interference

- Operation of the microwave oven may cause interference to your radio, TV or similar equipment.
- When there is interference, it may be reduced or eliminated by taking the following measures:
 - Clean door and sealing surfaces of the oven. (See Care of Your Microwave Oven, p. 33).
 - Place the radio, TV, etc. away from the microwave oven as far as possible.
 - Use a properly installed antenna to obtain stronger signal reception.

Safety Precautions

Follow These Safety Precautions When Cooking in Your Oven

1) HOME CANNING / DRYING FOODS / SMALL QUANTITIES OF FOODS

- **Do not** use your oven for home canning or the heating of any closed jar. Pressure will build up and the jar may explode. Your oven cannot maintain the food at the proper canning temperature. Improperly canned food may spoil and be dangerous to consume.
- Small quantities of food or foods with low moisture content can dry out, burn or catch on fire.
- **Do not** dry meats, herbs, fruits or vegetables in your oven.

IMPORTANT

Proper cooking depends on time set and weight of food. If you use a smaller portion than recommended and cook at the time for the recommended portion, fire can result.

If a fire occurs, turn oven off and leave oven door closed. Disconnect the power cord or shut off power at the fuse or circuit breaker panel.

2) POPCORN

Popcorn must be popped in a microwave oven corn popper. Microwave popcorn which pops in its own package is also available. Follow popcorn manufacturers' directions and use a brand suitable for the wattage of your microwave oven. Never leave oven unattended when popping popcorn. Allow the popcorn bag to cool before opening it. To prevent steam burns, always open the bag away from your face and body.

CAUTION:

When using pre-packaged microwave popcorn, follow recommended package instructions. Check package weight before using the Popcorn pad. Set the oven for the weight of the popcorn package. (see page 14) If these instructions are not followed, the popcorn may not pop adequately or may ignite and cause a fire.

3) DEEP FAT FRYING

- **Do not** attempt to deep fat fry in your microwave oven. Cooking oils may burst into flames and may cause damage to the oven and perhaps result in burns. Microwave utensils may not be able to withstand the temperature of the hot oil, and could shatter.

4) EGGS

- **Do not** heat eggs in their shell in a microwave oven. Pressure will build up and the eggs will explode.

5) FOODS WITH NONPOROUS SKINS

- **Potatoes, apples, egg yolks, whole squash and sausages are examples of foods with nonporous skins.** These types of foods must be pierced before microwave cooking to prevent their bursting.
- Use fresh potatoes for baking and cook until just done. Overcooking causes dehydration and may cause a fire. Use recommended weights or fire may occur.

6) LIQUIDS

- Heated liquids can erupt if not mixed with air. **Do not** heat liquids in your microwave oven without first stirring.

7) GLASS TRAY / COOKING UTENSILS / FOIL

- Cooking utensils get hot during Microwaving. Use potholders when removing utensils from the oven or when removing lids or plastic wrap covers from cooking utensils to avoid burns.
- The glass tray will get hot during cooking. It should be allowed to cool before handling or before paper products, such as paper plates or microwave popcorn bags, are placed in the oven for microwave cooking.
- When using foil, skewers, warming rack or utensils made of metal in the oven, allow at least 1-inch (2.5 cm) of space between metal material and interior oven walls. If arcing occurs (sparking) remove metal material (skewers etc.) and/or transfer to a non-metallic container.
- Dishes with metallic trim should not be used, as arcing may occur.

8) PAPER TOWELS / CLOTHS

- **Do not** use paper towels or cloths which contain a synthetic fiber woven into them. The synthetic fiber may cause the towel to ignite.
- **Do not** use paper bags or recycled paper products in the microwave oven.

9) BROWNING DISHES / OVEN COOKING BAGS

- Browning dishes or grills are designed for microwave cooking only. Always follow instructions provided by the manufacturer. Do not preheat browning dish more than 8 minutes.
- If an oven cooking bag is used for Microwave cooking, prepare according to package directions. Do not use a wire twist-tie to close bag.

10) THERMOMETERS

- **Do not** use a conventional meat thermometer in your oven. Arcing may occur.

11) BABY FORMULA / FOOD

- **Do not** heat baby formula or food in the microwave oven. The glass jar or surface of the food may appear warm while the interior can burn the infant's mouth and esophagus.

12) REHEATING PASTRY PRODUCTS

- When reheating pastry products, check temperatures of any fillings before eating. Some foods have fillings which heat faster and can be extremely hot while the surface remains warm to the touch (ex. Jelly Donuts).

13) GENERAL OVEN USAGE GUIDELINES

- **Do not** use the oven for any reason other than the preparation of food.
- **Do not** leave oven unattended while in use.

Cookware and Utensil Guide

ITEM	MICROWAVE	COMMENTS
Aluminum Foil	Yes, for Shielding only	Small strips of foil can be molded around thin parts of meat or poultry to prevent overcooking. Arcing can occur if foil is too close to oven wall or if too much foil is used.
Browning Dish	Yes	Browning dishes are designed for microwave cooking only. Check browning dish information for instructions and heating chart. Do not preheat for more than 6 minutes.
Brown paper bags	No	May cause a fire in the oven.
Dinnerware Labelled "Microwave-Safe"	Yes	Check manufacturers' use and care directions for use in microwave heating. Some dinnerware may state on the back of the dish, "Oven-Microwave Safe".
Other Dinnerware	?	Use CONTAINER TEST below.
Disposable polyester Paperboard Dishes	Yes	Some frozen foods are packaged in these dishes. Can be purchased in grocery stores.
Fast Food Carton with Metal Handle	No	Metal handle may cause arcing.
Frozen Dinner Tray Metal	Yes	Frozen dinners may be heated in foil tray, if tray is less than 3/4-inch (2 cm) high. Place foil tray in center of oven. Leave at least 1-inch (2.5 cm) space between foil tray and oven walls. Heat only 1 foil tray in the oven at a time. For containers more than 3/4-inch (2 cm) deep, remove food and place in a similar size microwave-safe container.
Microwave-safe	Yes	
Glass Jars	Yes, use caution	Remove lid. Heat food until just warm, not HOT. Most glass jars are not heat resistant. Do not use for cooking.
Glassware Heat Resistant Oven Glassware & Ceramics	Yes	Ideal for microwave cooking and browning. (See CONTAINER TEST below)
Metal Bakeware	No	Not recommended for use in microwave ovens.
Metal Twist Ties	No	May cause arcing which could cause a fire in the oven.
Oven Cooking Bag	Yes	Follow manufacturers' directions. Close bag with the nylon tie provided, a strip cut from the end of the bag, or a piece of cotton string. Do not close with metal twist tie. Make six 1/2-inch (1 cm) slits near the closure.
Paper Plates & Cups	Yes	Use to warm cooked foods, and to cook foods that require short cooking times such as hot dogs.
Paper Towels & Napkins	Yes	Use to warm rolls and sandwiches by microwave.
Parchment Paper	Yes	Use as a cover to prevent spattering. Safe for use in microwave, microwave/convection and conventional ovens.
Plastic Microwave-Safe Cookware	Yes	Should be labeled, "Suitable for microwave heating." Check manufacturers' directions for recommended uses. Some microwave-safe plastic dishes are not suitable for cooking foods with high fat or sugar content. The heat from hot food may cause the plastic to warp.
Reheat & Storage	Yes, use caution	
Melamine	No	This material absorbs microwave energy. Dishes get HOT!
Plastic Foam Cups	Yes	Plastic foam will melt if foods reach a high temperature. Use to bring foods to a low serving temperature.
Plastic Wrap	Yes	Use to cover food during cooking to retain moisture and prevent spattering. Should be labelled "Suitable for Microwave Heating". Check package directions.
Straw, Wicker, Wood	Yes	Use only for short term reheating and to bring food to a low serving temperature.
Thermometers Microwave-safe, only	Yes	Use only microwave-safe meat and candy thermometers. Not suitable for use in microwave oven, will cause sparks and get hot.
Conventional	No	
Wax paper	Yes	Use as a cover to prevent spattering and to retain moisture.

CONTAINER TEST

TO TEST A CONTAINER FOR SAFE MICROWAVE OVEN USE: Fill a 1-cup glass measure with water and place it in the microwave oven along with the container to be tested; heat one (1) minute at HIGH. If the container is microwave oven-safe, the container should remain comfortably cool and the water should be hot. If the container is hot, it has absorbed some microwave energy and should NOT be used. This test cannot be used for plastic containers.

Feature Diagram

Glass Tray

1. Do not operate the oven without the Roller Ring and Glass Tray in place.
2. Only use the Glass Tray specifically designed for this oven. Do not substitute any other Glass Tray.
3. If Glass Tray is hot, allow to cool before cleaning or placing in water.
4. **Do not** cook directly on Glass Tray. Always place food in a microwave-safe dish, or on a rack set in a microwave-safe dish.
5. If food or utensil on Glass Tray touches oven walls, causing the tray to stop moving, the tray will automatically rotate in opposite direction. This is normal.
6. Glass tray can rotate in either direction.

See-through Oven Window
with Vapor Barrier (*do not remove*)

Door Safety Lock System

External Air Vents

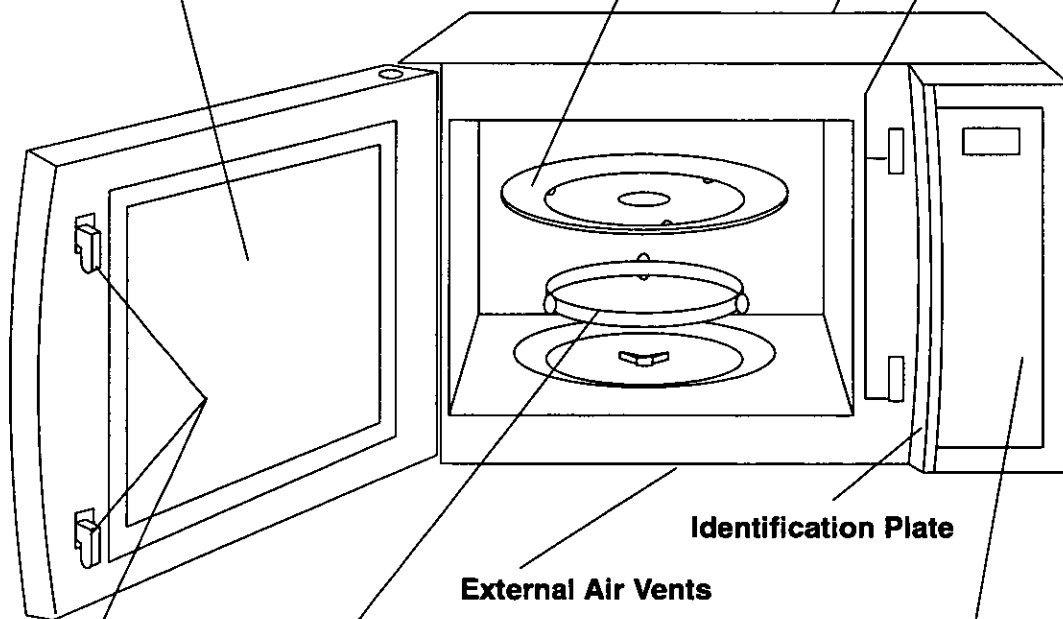

Identification Plate

External Air Vents

Roller Ring

1. The Roller Ring and oven floor should be cleaned frequently to prevent excessive noise.
2. The Roller Ring must always be used together with the Glass Tray for cooking.

Door Safety Lock System

Control Panel

- * Covered with a removable protective film to prevent scratches during shipping. Small bubbles may appear under this film. When this happens, remove film carefully. (Hint - apply masking or clear tape to an exposed corner and pull gently to remove.)
- * If the control panel becomes wet, clean with a soft dry cloth. Do not use harsh detergents or abrasives on the control panel.

Control Panel

NN-S688 / NN-S588

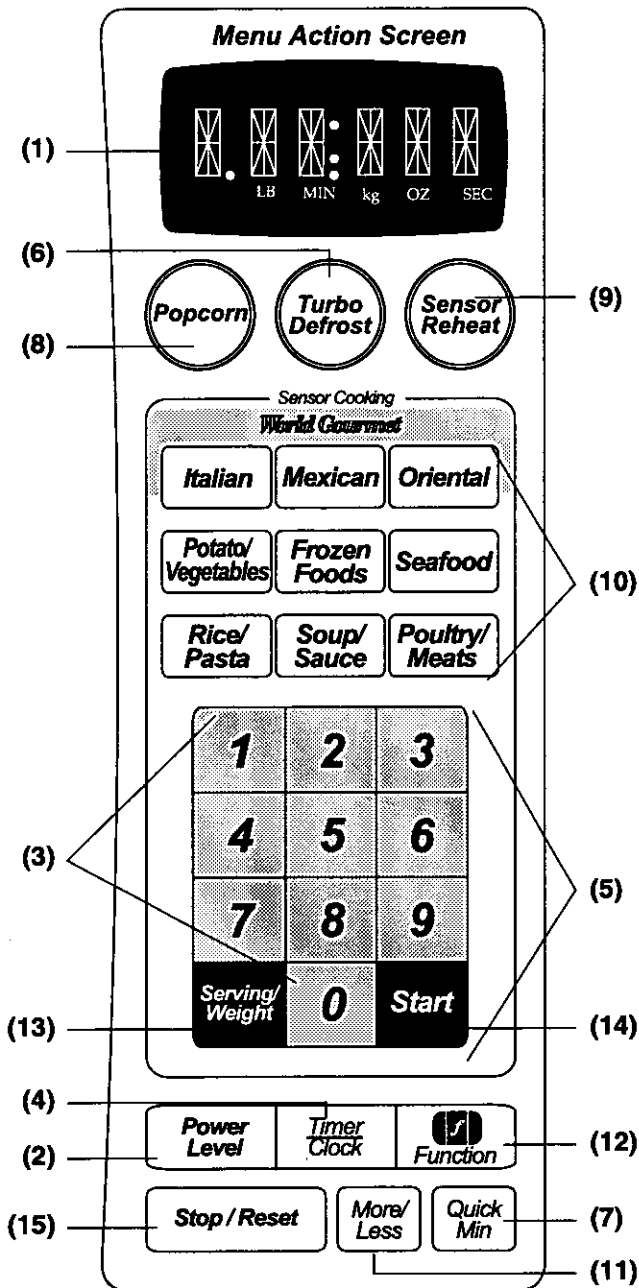

- (1) **Menu Action Screen**
Step by step instructions scroll for easy operation.
- (2) **Power Level Pad** (☛page 10)
- (3) **Number Pads**
- (4) **Timer/Clock Pad** (☛page 10, 11)
- (5) **Cook Action Display**
This totally unique feature of your PANASONIC guides you through the entire cooking process with its illuminated INTERACTIVE CONTROL PANEL. Once a pad has been selected, the COOK ACTION DISPLAY will blink to prompt you to the NEXT step until cooking starts.
- (6) **Turbo Defrost Pad** (☛page 12)
- (7) **Quick Min Pad** (☛page 14)
- (8) **Popcorn Pad** (☛page 14)
- (9) **Sensor Reheat Pad** (☛page 16)
- (10) **Sensor Cooking Pads** (☛page 16-18)
- (11) **More/Less Pad** (☛page 16)
One tap allows you to add to the Sensor cooking time. Two taps allows you to program less time when using the Sensor cook pads.
- (12) **Function Pad** (☛page 8-9)
- (13) **Serving/Weight Pad** (☛page 14)
- (14) **Start Pad**
One tap allows oven to begin functioning. If door is opened or **Stop/Reset Pad** is pressed once during oven operation, **Start Pad** must again be pressed to restart oven.
- (15) **Stop/Reset Pad**
Before cooking: One tap clears your instruction.
During cooking: One tap temporarily stops the cooking process. Another tap cancels all your instructions and time of day or colon appears on the screen.

Prompters:

When pads are pressed, a beep sound is heard and the corresponding letter or word(s) appear and roll across the **Menu Action Screen** (either the **Beep Sound** or screen may be disabled using the **Function Pad**). If a pad is pressed and no beep is heard, the unit has not or cannot accept the instruction. As each pad is pressed the corresponding word(s) roll across the screen. Words will automatically appear to prompt user to perform the next step. It is not necessary to wait for the words to appear before pressing pads for the next step. A two beep sound is usually heard between stages.

Let's Start to Use Your Oven!

1 Plug in

Plug into a properly grounded electrical outlet. "WELCOME TO PANASONIC REFER TO OPERATING INSTRUCTIONS BEFORE USE" scrolls across the Menu Action Screen. Use **Function** pad to select French or Spanish.

2 Place a cup of water in the oven

Open the door and place a cup of water on the Glass Tray in the oven. Then close the door.

3 Select Power Level

e.g. MEDIUM Power — Press **Power Level** Pad four times (see page 10 for chart)

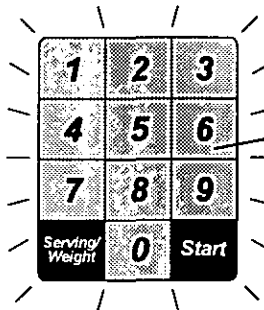
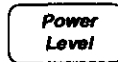

4 Set Cooking Time using number pads

e.g. 1 minute 30 seconds





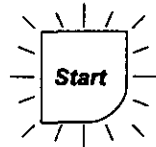

5 Press Start



► The time in the Menu Action Screen will count down.

A unique feature of your PANASONIC 1100w microwave oven is the FUNCTION pad. The initial settings of your microwave are LANGUAGE = ENGLISH, WEIGHT = LB, WORD SPEED = MEDIUM, MENU ACTION SCREEN = ON, CHILD LOCK = OFF, BEEP = ON, REMINDER BEEP = OFF, DAYLIGHT SAVING = OFF, CLOCK = ON, DEMO MODE = OFF. To change any setting, see page 9 (FUNCTION PAD) for other options.

To Use Function Pad

<p>1)  </p>	<p>Press: FUNCTION. Menu Action Message is "Select Function 0 through 9, 1--LANGUAGE CHOICE --- etc". Number pad flashes.</p>
<p>2) Select a number (0-9) Ex. CHILD LOCK is 5</p>	<p>Press: Menu Action Message is "5 -- CHILD LOCK ON/OFF Numbers flash.</p>
<p>3) Select ,  or </p>	<p>Press: One number. Your selection is now part of the operating system. You can change it any time.</p>
<p>4) Continue until you have completed your selections.</p>	<p>See page 9 for other options.</p>

Functions

This unique feature of your PANASONIC microwave oven allows you to establish the initial non-cooking features of your oven such as CHILD LOCK, WORD SPEED, LANGUAGE CHOICE (ENGLISH, SPANISH OR FRENCH), plus many more. See below.

	<p>→ 1</p>	<p>LANGUAGE CHOICE</p> <p>The oven has English, French and Spanish display. The display appears in English when you plug-in.</p> <p>1 ENGLISH → Display appears in English. 2 FRANCAIS → Display appears in French. 3 ESPANOL → Display appears in Spanish.</p>
	<p>→ 2</p>	<p>Lb/KG CHOICE</p> <p>The oven has both imperial and metric weight measurements. The oven displays the weight in imperial when you plug it in.</p> <p>1 Lb → Weight can be set in lb/oz, (Imperial). 2 KG → Weight can be set in kg/g, (Metric).</p>
	<p>→ 3</p>	<p>WORD SPEED</p> <p>The speed of word scrolling in the Display Window can be quickened or slowed down.</p> <p>1 QUICK → Words scroll quickly. 2 MEDIUM → Scrolling speed reverts to initial setting. 3 SLOW → Words scroll slowly.</p>
	<p>→ 4</p>	<p>MENU ACTION ON/OFF</p> <p>MENU ACTION SCREEN helps you to program your oven by prompting the next step to be taken. When you become familiar with your oven, the prompting can be turned off.</p> <p>1 ON → Prompting Guide will reappear. 2 OFF → Prompting Guide will not appear.</p>
	<p>→ 5</p>	<p>CHILD LOCK ON/OFF</p> <p>The oven has Child Safety Lock feature which prevents use by children. It does not lock the door.</p> <p>1 ON → Child Lock has been set and operation will not be accepted. 2 OFF → Child Lock has been cancelled.</p>
	<p>→ 6</p>	<p>BEEP ON/OFF</p> <p>If you wish to have the oven operate with no beep, it can be eliminated.</p> <p>1 ON → Beep sound will reactivate. 2 OFF → Beep sound will not be heard.</p>
	<p>→ 7</p>	<p>REMINDER BEEP ON/OFF</p> <p>A reminder beep works to remind you to remove the food from the oven after the completion of cooking. It will occur every few seconds.</p> <p>1 ON → Reminder beep will work. 2 OFF → Reminder beep will not work.</p>
	<p>→ 8</p>	<p>DAYLIGHT SAVING ON/OFF</p> <p>1 ON → Time of day will advance one hour. 2 OFF → Time of day revert to original setting.</p>
	<p>→ 9</p>	<p>CLOCK ON/OFF</p> <p>Clock display can be turned off.</p> <p>1 ON → Clock display will appear in the Display Window. 2 OFF → Clock display will not appear in the Display Window. Time of day will not be lost while the display is off.</p>
	<p>→ 0</p>	<p>DEMO MODE ON/OFF</p> <p>Demo mode is designed for retail store display. In this mode, the oven can be demonstrated with no power in the oven.</p> <p>1 ON → The oven will be in demo mode. 2 OFF → The oven will be out of demo mode.</p>

Power & Time Setting

1 Select Power Level



Press	Power Level	% Power
once	HIGH	100%
twice	DEFROST	30%
3 times	MEDIUM-HIGH	70%
4 times	MEDIUM	55%
5 times	MEDIUM-LOW	30%
6 times	LOW	10%

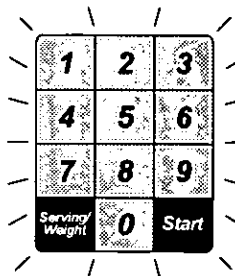

When selecting **HIGH** Power, you can start from step 2.
MENU ACTION MESSAGE is " - - - SET TIME".
(Number pad flashes.)

2 Set Cooking Time

(Up to 99 minutes and 99 seconds) e.g. 12 minutes
Number pad flashes until you enter time.

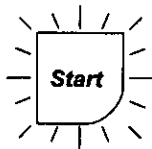
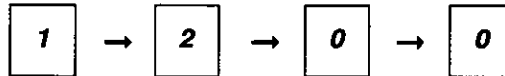

3 START Flashes

MENU ACTION MESSAGE is " - - - PRESS START". If the door is opened "CLOSE DOOR".

► Cooking will start. The time in the Menu Action Screen will begin to count down.

To recall the selected power level during cooking, press Power Level Pad.

For 2 or 3 stage cooking, repeat above steps 1 and 2 before pressing Start Pad.

At the end of cooking, MENU ACTION MESSAGE IS "ENJOY YOUR MEAL".

To Set Clock

1.		PRESS twice for <i>Clock</i> . MENU ACTION MESSAGE is "SET TIME : ". Number pad flashes.
2. SET TIME OF DAY (ex. 1:30)		MENU ACTION MESSAGE is " 1:30 -- PRESS CLOCK PAD".
3.		Press once. Menu Action Screen displays time of day (clock is a 12 hour clock).

Timer Function

This feature allows you to program a standing time after cooking is completed and to program the oven as a minute timer and/or to program delay start.

To Use as a Timer

1 Press Timer

PRESS once for TIMER. MENU ACTION MESSAGE is "TIMER -- SET TIME" (up to 99 min & 99 seconds). Number pad flashes.

2 Set desired amount of Time

Example: Set the time for 15 minutes using flashing number pad

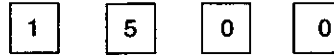

MENU ACTION MESSAGE is "TIMER 15 min 00 sec -- PRESS START". *Start* flashes.

3 Press Start

Display counts down without oven operating. Five beeps will normally sound at the end (see *Function* pad for options). MENU ACTION MESSAGE is "ENJOY YOUR MEAL".

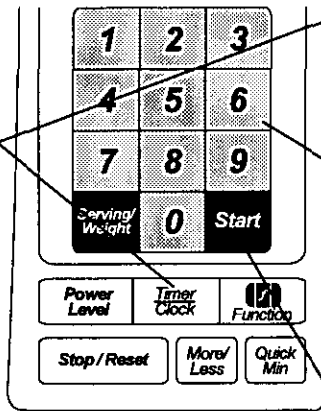

To Set Stand Time

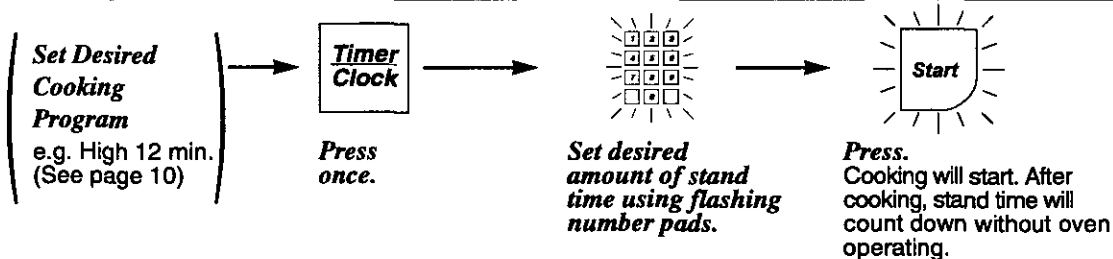

To Set Delay Time

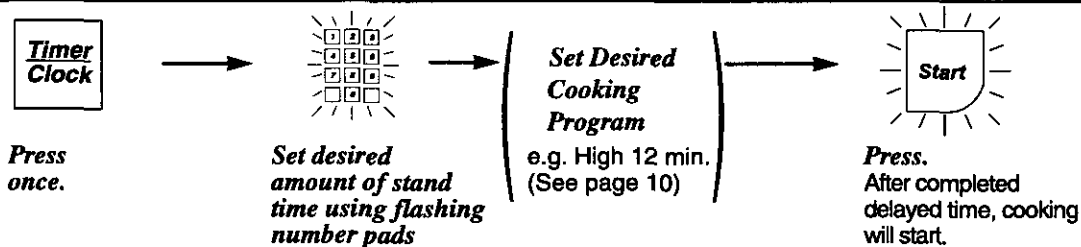

NOTE:

1. When the first/second stage has finished, a two beep signal is heard. After all the stages have been completed, the oven will beep five times.
2. If oven door is opened during the Stand Time of Kitchen Timer, the time in the Display Window will continue to count down.
3. Delay Start cannot be programmed before any Sensor Control Function. This is to prevent the starting temperature of the food from rising before defrosting or cooking begins. A change in the starting temperature could cause inaccurate cooking results.
4. Timer can be set up to 99 minutes and 99 seconds.

Turbo Defrost

Menu Action Screen

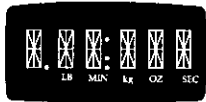

This feature allows you to defrost meat, poultry and seafood by weight without setting time.

1 Press Turbo Defrost Pad

MENU ACTION MESSAGE is

"DEFROST -SET WEIGHT". If you have selected the weight system of lbs/oz, "LB OZ" will appear.

If you have selected Kg as the weight system, "kg" will appear.

Number pads flash.

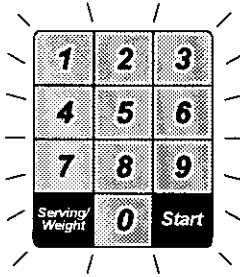

2 Weight of Frozen Food

Enter weight using number pads.

ex. 2.5 lbs. is 2 lbs. 8 oz. (see conversion chart below)

Imperial	metric
2 lbs 8 oz	2.5 kg
<input type="text" value="2"/> . <input type="text" value="0"/> <input type="text" value="8"/>	<input type="text" value="2"/> . <input type="text" value="5"/>

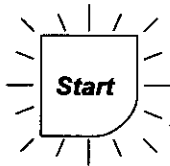

3 START Flashes

After weight has been entered, **Start** flashes.



4 Press START

Defrost time will display and count down.

Conversion Chart

Follow this chart to convert tenths of a pound into ounces. If a piece of meat weighs 1.9 pounds, program 1 pound 14 ounces.

Tenths of a Pound	Ounces
0.0	0
0.1	1 - 2
0.2	3 - 4
0.3	5
0.4	6 - 7
0.5	8
0.6	9 - 10
0.7	11 - 12
0.8	13
0.9	14 - 15

NOTE:

1. The shape and size of the food will determine the maximum weight the oven can accommodate. The recommended **maximum weight of meat is 4 lb. (1.8 kg); poultry, 6 lb. (2.7 kg) and seafood, 3 lb. (1.4 kg).**
2. The oven beeps once during the defrosting cycle to signal that the food needs to be **turned or rearranged**. To prevent overdefrosting, thin areas of edges can be shielded with strips of aluminum foil.
3. For best results, the minimum recommended weight **8 oz. (220 g).**
4. Stand time or power level may be programmed after Turbo Defrost.

Defrosting Tips & Techniques

1. Freeze meats, poultry and fish in packages with **only 1 or 2 layers** of food. Place wax paper between layers.
2. **Package** in heavy-duty plastic wraps, bags or freezer paper.
3. **Remove as much air** as possible.
4. Wrap should be snug against food, sealed securely and labeled.
5. **Remove wrapper** to prevent holding steam and juice. **Juice of food** can get hot and cause the outer surface or bottom of the food to cook; set the food on a microwave roasting rack and drain liquid during defrosting.
6. **Place meat in an appropriate size dish.**
7. **Place roast fat-side down** and **whole poultry breast-side down** on a microwave roasting rack in a dish.
8. Place small items on a microwave roasting rack in a dish.
9. **Large roasts** and **whole poultry** may still be icy in center after defrosting, allow to stand in the refrigerator covered with plastic wrap (see chart below).
10. Fish and seafood should be slightly icy after defrosting, allow to stand and rinse under cold water for 2-3 minutes.
11. Defrosted items in 2 layers should be **rinsed separately** or **have a longer stand time.**

FOOD	DEFROST TIME (min. per pound)	DURING DEFROSTING	AFTER DEFROSTING	
			Stand Time	Rinse
Fish and Seafood [up to 3 lb. (1.5 kg)]				
Crabmeat	12 to 14	Break apart	5 min.	NO
Fish Steaks	6 to 10	Turn over		
Fish Fillets	6 to 8	Turn over/Rearrange		
Sea Scallops	14 to 16	Break apart/Remove defrosted pieces	5 min.	YES
Shrimp medium	8 to 10	Break apart/Remove defrosted pieces		
Whole fish	10 to 12	Turn over		
Meat				
Ground Meat	8 to 10	Turn over/Remove defrosted portion/Shield edges	10 min.	NO
Roasts [2½ - 4 lb. (1.2 - 2 kg)]	8 to 12	Turn over/Shield ends and defrosted surface	30 min. in refrig	
Chops/Steak	8 to 10	Separate/Turn over/Rearrange	5 min.	
Ribs/T-bone	8 to 10	Turn over/Shield		
Stew Meat	10 to 12	Break apart/Shield		
Liver (thin sliced)	8 to 10	Drain liquid/Turn over/Separate pieces		
Bacon	4 to 6	Turn over		
Poultry				
Chicken, Whole [up to 3 lb. (1.5 kg)]	6 to 10	Turn over 2 or 3 times/Shield defrosted parts	20 min. in refrig	YES
Cutlets	6 to 8	Turn over	5 min.	NO
Pieces	8 to 10	Separate	10 min.	
Cornish Hens	8 to 12	Turn over/Rearrange		20 min. in refrig
Turkey Breast [5 - 6 lbs. (2.5 - 3 kg)]	8 to 12	Turn over 2 to 3 times		

Popcorn Function



Set the desired weight of prepackaged microwave popcorn.

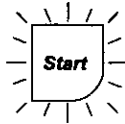
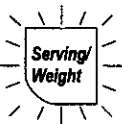

Press.
 ► Time appears on the screen and begins to count down.

Press	Weight
once	3.5 oz.(99 g)
twice	3.0 oz.(90 g)
3 times	1.75 oz.(50 g)

NOTES:

1. Use prepackaged **room temperature** microwave popcorn. Read manufacturers' instructions.
2. Place bag in oven according to manufacturers' directions.
3. Pop only one bag at a time.
4. After popping, open bag carefully, popcorn and steam are extremely hot.

5. Do not reheat unpopped kernels or reuse bag.
6. **Never** leave oven unattended when popping popcorn.

CAUTION:

If pre-packaged popcorn is of a different weight than the recommended weight, do not use the popcorn setting, or inadequate popping or a fire may occur. Follow the manufacturers' instructions.

Quick Min

This feature allows you to set cooking times easily instead of using Number Pads or to add extra cooking time.

To Set Cooking Time:



1. Press to set cooking time (up to 10 minutes).
 2. Press **Start** Pad. Cooking will start on **HIGH** power.
- To use other power levels, select the desired power level before setting the cooking time.
 - If you use **Quick Min** Pad to set your cooking time, you cannot use Number Pads to set more time or to change the cooking time. However, you can add more time with **Quick Min** Pad during cooking.

To Add Extra Cooking Time during cooking:



Press **Quick Min** Pad to add extra cooking time (up to 10 taps) during cooking.

- Cooking time changes to include extra time and continues to count down in the display.
- Extra time can be added during any of the three stages.

Microwave Shortcuts

FOOD	POWER	TIME (in minutes)	DIRECTIONS
To Melt Butter , ¼ pound To Soften Butter , ¼ pound	MEDIUM MEDIUM-LOW	1 - 2 ½ - 1	Remove wrapper and place butter in a microwave-safe dish.
To Melt Chocolate , 1 square (1 oz.) To Melt Chocolate , ½ cup chips	MEDIUM MEDIUM	2 - 3 2 - 3	Remove wrapper and place chocolate in dish. Stir before adding more time. Chocolate holds its shape even when softened.
To Separate Bacon , 1 lb.	HIGH	½ - 1	Remove wrapper. After heating, use a plastic spatula to separate slices.
To Soften Cream Cheese , 3 oz.	MEDIUM-LOW	½ - 1	Remove wrapper and place in a bowl.
Cup of Water 1 cup (8 oz.) 2 cups (16 oz.) Cup of Milk 1 cup (8 oz.) 2 cups (16 oz.)	HIGH HIGH MEDIUM-HIGH MEDIUM-HIGH	4 6½ 3½ - 4½ 7 - 8	Heated liquids can erupt if not mixed with air. Do not heat liquids in your microwave oven without stirring first.
To Toast Coconut , ⅓ cup	HIGH	1 - 3	Place in a pie plate or bowl. Stir every 30 seconds.
To Brown Ground Beef , 1 lb.	HIGH	3 - 5	Crumble in microwave-safe colander set in another dish. Stir twice.
To Soften Ice Cream , ½ gallon	MEDIUM-LOW	3 - 4	—————
To Roast Nuts , 1½ cups	HIGH	3 - 5	Spread nuts in 9-inch pie plate. Stir twice.
To Toast Sesame Seeds , ¼ cup	HIGH	2½ - 4	Place in a small bowl. Stir twice.
To Soften Brown sugar	HIGH	½ - ¾	Place 1 cup hard brown sugar in dish with a slice of bread or a wedge of apple. Cover with plastic wrap.
To Remove Oven Odors	HIGH	5	Combine 1 to 1½ cups of water with the juice and peel of one lemon in a small bowl. After heating, wipe interior of oven with damp cloth.

Sensor Reheat / Sensor Cooking

The **GENIUS** feature allows you to reheat/cook most of your favorite foods without having to select reheating/cooking times and power levels. THE OVEN DOES IT ALL FOR YOU.

Sensor Cook Pads

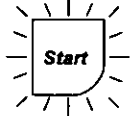
<p>1) Select SENSOR PAD ex. Potatoes (any quantity)</p> <div style="display: flex; justify-content: space-around; align-items: flex-start;"> <div style="border: 1px solid black; padding: 2px; text-align: center; width: 40px;">Potato/ Vegetables</div> <div style="border: 1px solid black; padding: 2px; text-align: center; width: 40px;">Potato/ Vegetables</div> <div style="border: 1px solid black; padding: 2px; text-align: center; width: 40px;">Frozen Foods</div> <div style="border: 1px solid black; padding: 2px; text-align: center; width: 40px;">Seafood</div> <div style="border: 1px solid black; padding: 2px; text-align: center; width: 40px;">Rice/ Pasta</div> <div style="border: 1px solid black; padding: 2px; text-align: center; width: 40px;">Soup/ Sauce</div> <div style="border: 1px solid black; padding: 2px; text-align: center; width: 40px;">Poultry/ Meats</div> </div>	<p>PRESS until proper food is displayed. MENU ACTION MESSAGE is "POTATO -- PRESS START".</p>
<p>2) MORE/LESS* Optional</p>	
<p>3)</p> <div style="text-align: center;">  </div>	<p>PRESS. MENU ACTION MESSAGE is "POTATO". Cooking will start. After steam is detected by the SENSOR, 2 beeps will sound, the remaining cooking time appears in the display window and begins to count down. 5 beeps will sound at the end of cooking. To recall the selected category during cooking, press any sensor cooking pad. The category will appear in the display.</p>

*MORE/LESS PAD

Preferences for food doneness vary with each individual. After having used Sensor Cooking a few times, you may decide you would prefer your food cooked to a different doneness. By using the **More/Less** pad, the programs can be adjusted to cook food for a longer or shorter time.

1 tap = MORE cooking

2 taps = LESS cooking

Press **MORE/LESS** before pressing **START**.

Sensor Reheat Pad

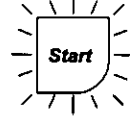
<p>1)</p> <div style="text-align: center;">  </div>	<p>PRESS. MENU ACTION MESSAGE is "SENSOR REHEAT -- PRESS START". Start flashes.</p>
<p>2) MORE/LESS* Optional</p>	
<p>3)</p> <div style="text-align: center;">  </div>	<p>PRESS. MENU ACTION MESSAGE is "SENSOR REHEAT -- CLOSE DOOR". Sensor evaluation begins. After 2 beeps, display will count-down.</p>

NOTES ON SENSOR REHEAT:

Casseroles - Add 3 to 4 tablespoons of liquid; cover with lid or plastic wrap. Stir when time appears in the display window.

Canned foods - Empty contents into casserole dish or serving bowl; cover dish with lid or plastic wrap. After reheating, release plastic wrap and stand.

Plate of food - Arrange food on plate; top with butter, gravy, etc. After reheating, release plastic wrap and stand.

Follow the recommendations on page 16, in addition to the following:

DO NOT:

1. Reheat bread and pastry products. Use manual power and time for these foods.
2. Reheat raw or uncooked food.
3. Use if oven cavity is warm.
4. Use for beverages.
5. Use for frozen foods.

Sensor Cooking

	CATEGORY	WEIGHT RANGE	INSTRUCTIONS
Potato/ Vegetables	1 x Potato	any size	Pierce several times and place on a microwave safe dish. Do not cover. After beep, turn over.
	2 x Fresh Vegetables	any size	Add water. Cover loosely with a lid or plastic wrap. After beep, stir or rearrange.
	3 x Frozen Vegetables	any size	Add 2 tbsp of water. Do not cook with butter or sauce. Cover with plastic wrap. After beep, stir or rearrange.
Rice/ Pasta	1 x Rice	Rice . . . Cold water ½ cup . . . 1 cup 1 cup . . . 2 cups 1½ cup . . . 3 cups 2 cups . . . 3½ cups	Place rice and cold water with ¼ to 1 teaspoon salt. Cover with lid or plastic wrap. After beep, stir several times. After cooking, stir and let stand 5 to 10 mins.
	2 x Pasta	4 - 8 oz. (120 - 230 g)	Place 1½-quarts of hot water, pasta, 1 tbsp. oil and 1 tsp. salt in a 4-qt. casserole. Cover with lid. After beep, stir occasionally. After cooking, rinse pasta with cold water.
Frozen Foods	1 x Frozen Entrees	any size	Follow manufacturers' directions for covering or removing covers. For best results, do not use frozen foods packaged in foil tray. After beep, stir if possible or ladle gravy or sauce over.
	2 x Frozen Dinners	any size	
Soup/ Sauce	1 x Soup	any size	Pour soup into microwave-safe container. Cover loosely with lid or plastic wrap.
	2 x Sauce	any size	Pour sauce into microwave-safe container. Cover loosely with lid or plastic wrap.
Seafood	1 x Fish Fillets	½ - 1½ lb. (230 - 680 g)	Arrange in a single layer in dish. Cover with lid or plastic wrap. Stir or rearrange after beep.
	2 x Shellfish	½ - 1½ lb. (230 - 680 g)	
Poultry/ Meats	1 x Bacon	2, 3, 4 or 6 slices	Place on microwave safe dish. Cover with paper towels.
	2 x Chicken Pieces	½ - 2 lb. (230 g - 1 kg)	Place skin-side up. Cover with plastic wrap. Rearrange after beep.
	3 x Whole Chicken	up to 6 lb. (3 kg)	Place breast-side down. Cover completely with plastic wrap. After beep, turn breast-side up, recover.
	4 x Pork (roast)	2 - 4 lb. (1 - 2 kg)	Place fat-side down. Cover with plastic wrap. After beep, turn over, recover, shield ends of roast with foil if necessary. Pork must reach 170°F (77°C) before serving.
	5 x Ground Meat	½ - 2 lb. (230 g - 1 kg)	Break apart in glass bowl or colander. Cover loosely with plastic wrap. After 2 beeps, the oven will stop and time will appear in the Display Window. Stir to break meat apart. Press Start . Display will continue to count down. Juices should be clear. Drain.

For best results by Sensor, follow these recommendations.

BEFORE Reheating/Cooking:

1. The room temperature surrounding the oven should be below 95°F (35°C).
2. Food weight should be between 4 oz (120 g) and 24 oz (680 g).
3. Glass Tray and outside of container should be dry.
4. Cover foods loosely, but completely, with plastic wrap or place foods in a casserole dish with a proper fitting lid.
5. All foods should be taken from their normal storage place.

DURING Reheating/Cooking:

While "AUTO" is displayed in the display window, DO NOT open door. This causes inaccurate cooking results. Once the timer begins to count down, the oven door may be opened to stir, turn, shield or add foods.

AFTER Reheating/Cooking:

All foods should have a covered stand time.

World Gourmet Cooking

Welcome to International Cooking with Panasonic.

This feature allows you to choose a recipe, prepare it, select the program and then touch **Start**. The **Panasonic Genius** completes the process by completely cooking your food. ENJOY.

Example: Oriental Spare Ribs

1. Prepare recipe according to directions.

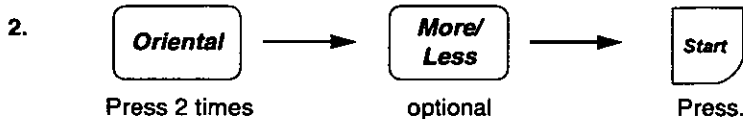

3. Stir and let stand according to recipe.

Key Pad	Category	Preparation	Instructions
Italian	Chicken Cacciatore	Prepare according to recipe on page 19. Cover with plastic wrap.	After cooking, cover and let stand for 5 minutes.
	Easy Lasagna	Prepare according to recipe on page 19. Cover with plastic wrap.	After 2 beeps, time appears in Display Window. Check corners and shield if needed. Re-cover. Press Start . After cooking, add Parmesan cheese. Cover and let stand for 5 minutes.
	Chicken Parmigiana	Prepare according to recipe on page 19. Cover with plastic wrap.	After 2 beeps, time appears in Display Window. Rearrange, add toppings, re-cover. Press Start . After cooking, add mozzarella cheese. Cover and let stand for 5 minutes.
Mexican	Mexican Chicken	Prepare according to recipe on page 20. Cover with plastic wrap.	After 2 beeps, time appears in Display Window. Turn over, rearrange and baste with sauce. Press Start . After cooking, add cheese and let stand for 5 minutes.
	Fiesta Chicken Roll-Ups	Prepare according to recipe on page 20. Cover with plastic wrap.	After 2 beeps, time appears in Display Window. Turn over, rearrange and baste with sauce. After cooking, drain (if needed). Prepare for serving.
	Chili Tacos	Prepare meat according to recipe on page 20. Cover with plastic wrap.	After 2 beeps, time appears in Display Window. Stir with large spoon, re-cover. Press Start . After cooking, assemble tacos.
Oriental	Chicken Teriyaki	Marinate 30 min. before cooking. See recipe on page 21. Cover with plastic wrap.	After 2 beeps, time appears in Display Window. Turn over, rearrange and baste with sauce. Re-cover. Press Start . After cooking, let stand covered for 5 minutes.
	Oriental Spareribs	Prepare according to recipe on page 21. Cover with plastic wrap.	After 2 beeps, time appears in Display Window. Turn over, rearrange and baste with sauce. Re-cover. Press Start . After cooking, let stand covered for 5 minutes.
	Shrimp Oriental	Prepare sauce according to recipe on page 21. Cook, 2-3 min. on HIGH. Add shrimp & onions. Cover with plastic wrap. Press Oriental . (Shrimp Oriental)	After 2 beeps, time appears in Display Window. Turn over, rearrange and baste with sauce. Re-cover. Press Start . After cooking, let stand covered for 5 minutes.

Recipes for World Gourmet

ITALIAN - Easy Lasagna

MEAT SAUCE

1/2 pound ground beef
1 jar (30 oz.) spaghetti
1/2 cup water

CHEESE SAUCE

1 container (15 oz.) ricotta or cottage cheese
1 egg, slightly beaten
1/2 teaspoon salt
1 teaspoon white pepper
9 lasagna noodles cooked (see **Pasta**, page 29).
1/2 pound mozzarella cheese, thinly sliced
1/2 cup grated Parmesan cheese.

MEAT SAUCE

Crumble ground meat into microwave safe bowl or colander. Cook on High, 1 1/2 - 2 1/2 minutes or until beef is cooked. Stir once. Drain. Stir in spaghetti sauce and water. Cook on High, 3 1/2 - 4 1/2 minutes.

CHEESE SAUCE

In a separate dish, combine ricotta cheese, egg, salt and pepper.

Spoon 1/4 of meat sauce into rectangular baking dish (or oval dish that fits your oven). Alternate layers of noodles, cheese mixture, mozzarella cheese and meat sauce for 3 layers. Cover with plastic wrap and cook on **ITALIAN (Easy Lasagna)**. After time appears in the Display Window, shield corners (see page 23 "Shielding"), if necessary. At the end of cooking, sprinkle with Parmesan cheese; re-cover. Let stand covered, 5 minutes before serving.

Yield: approx. 8 servings

ITALIAN - Chicken Parmigiana

1 egg
1/4 cup water
1 cup seasoned dry bread crumbs
1/2 cup grated Parmesan cheese
1/4 teaspoon paprika
2 boneless chicken breasts, halved
2 tablespoons oil, divided
1 can (8 oz.) tomato sauce
or 1 cup spaghetti sauce
Oregano
1 cup (4 oz.) shredded mozzarella cheese

Beat egg with water. In a separate bowl, combine bread crumbs, Parmesan cheese and paprika. Dip chicken in breadcrumb mixture, then in egg mixture and again in breadcrumb mixture. Coat bottom of 8 inch square dish with 1 tablespoon oil. Place coated chicken in dish; sprinkle with remaining oil.

Cook on **ITALIAN (Chicken Parmigiana)**, covered with plastic wrap.

After time appears in Display Window, open door.

Rearrange and turn chicken over.

Add tomato sauce and oregano. Re-cover. Press **Start**.

After cooking, top with mozzarella.

Let stand, covered, 5 minutes or until cheese melts.

Yield: 4 servings

ITALIAN - Chicken Cacciatore

2 pounds chicken parts
1 can (8 oz.) tomato sauce
1 can (6 oz.) tomato paste
1 can (4 oz.) sliced mushrooms, drained
1/2 cup chopped onion
1 tablespoon sugar, optional
1/2 teaspoon oregano
1 teaspoon salt
1 clove garlic, finely chopped
1/4 teaspoon pepper

Arrange chicken in 2 1/2 quart oval dish with meatier portions toward the edge of dish. Combine remaining ingredients and pour over chicken. Cover with plastic wrap. Cook on **ITALIAN (Chicken Cacciatore)**. After cooking, vent & let stand, covered 5 minutes. Serve with spaghetti, if desired.

Yield: 4 servings

Recipes for World Gourmet

MEXICAN - Chili Tacos

- 1 pound lean ground beef
- 1 package (1 $\frac{1}{4}$ oz.) taco seasoning mix
- $\frac{1}{2}$ cup water

- 12 taco shells
- 1 cup shredded lettuce
- $\frac{2}{3}$ cup chopped tomatoes
- $\frac{1}{4}$ cup chopped green pepper or onion
- 1 cup (4 oz.) shredded Cheddar or Monterey Jack Cheese

Combine ground beef, seasoning mix and water in a 2 quart casserole. Cover with lid or plastic wrap. Cook on **MEXICAN (Chili Tacos)**. After time appears in Display Window, stir. Re-cover and press **Start**. After cooking, stir and let stand covered for 3 minutes.

To Complete:
Fill taco shells with 2 tablespoons drained beef mixture. (Hint: use slotted spoon). To serve, top with lettuce, tomato, green pepper and cheese.

Yield: 12 tacos

MEXICAN - Mexican Chicken

- 1 can (15 oz.) tomato sauce
- 2 to 3 tablespoons jalapeno peppers, finely chopped
- 2 tablespoons chopped onion
- $\frac{3}{4}$ teaspoon chili powder
- $\frac{1}{4}$ teaspoon cumin
- $\frac{1}{4}$ teaspoon crushed red pepper
- 1 $\frac{1}{2}$ - 2 pounds chicken pieces (skinned-optional)
- 2 oz. Monterey Jack cheese, shredded, (optional)

SAUCE

In a small bowl, combine tomato sauce, jalapeno peppers, onion, chili powder, cumin and red pepper. Arrange chicken skin side down in a 2 $\frac{1}{2}$ quart shallow oval casserole dish. Spread sauce evenly over chicken. Cover with plastic wrap. Cook on **MEXICAN (Mexican Chicken)**. After time appears in Display Window, rearrange chicken, turn over and baste with sauce. Re-cover with plastic wrap. Press **Start**. At the end of cooking, sprinkle with cheese. Re-cover, let stand 5 minutes before serving.

Yield: 4 servings

MEXICAN - Fiesta Chicken Roll-Ups

- 2 boneless chicken breast (1 - 1 $\frac{1}{2}$ lb.), skinned, split and pounded thin
- Chili powder
- Pepper
- $\frac{1}{2}$ cup (2 oz.) Cheddar cheese, cut into quarters
- $\frac{1}{4}$ cup sliced green olives
- $\frac{3}{4}$ cup crushed taco or corn chips
- 1 can (8 oz.) taco sauce

Season one side of each chicken breast with chili powder and pepper. Place one stick of cheese on each breast. Sprinkle 1 tablespoon of olives down center. Fold edges over to enclose filling. Secure with wooden toothpicks. Arrange seam-side down in 8-inch square dish. Cover with plastic wrap. Cook on **MEXICAN (Fiesta Chicken Roll-Ups)**. After time appears in Display Window, open door, rearrange, turn chicken over and re-cover. Press **Start**. Let stand, covered, 5 minutes. Drain, if necessary.

While chicken is standing, cook taco sauce for 2 - 3 minutes on HIGH or until hot. Pour sauce over chicken, sprinkle with chips and serve.

Yield: 4 servings

Recipes for World Gourmet

ORIENTAL - Chicken Teriyaki

SAUCE

1 can (8 oz.) chunk pineapple in pineapple juice
1 clove garlic, finely chopped
1/4 cup soy sauce
2 tablespoons packed brown sugar
1/2 teaspoon salt
1/4 teaspoon ginger

1 1/2 - 2 pounds chicken pieces.

In a small bowl, combine all sauce ingredients. Marinate chicken 30 minutes in sauce. Arrange chicken skin-side down in 2 1/2 quart shallow oval casserole dish with meatier portions toward edge of dish. Pour sauce over chicken. Cover with plastic wrap.

Cook on **ORIENTAL (Chicken Teriyaki)**.

After time appears in Display Window, rearrange and turn chicken over. Re-cover and press **Start**. Let stand 5 minutes. Spoon pineapple sauce over chicken before serving.

Yield: 4 servings

ORIENTAL - Shrimp Oriental

SAUCE

1/2 cup water
3 tablespoons soy sauce
2 tablespoons sherry
1/8 teaspoon hot pepper sauce
1 clove garlic, finely chopped
2 tablespoons cornstarch
1 package (6 oz.) frozen pea pods,
defrosted and drained (see page 28)
1 can (8 oz.) bamboo shoots, drained
Hot cooked rice, optional (see page 29)

1 1/4 pounds large shrimp, shelled and cleaned
4 green onions, sliced

In a 3 quart casserole, combine water, soy sauce, sherry, hot pepper sauce and garlic. Blend in cornstarch until smooth. Stir in pea pods and bamboo shoots. Cover with lid or plastic wrap. Cook 2 1/2 - 3 minutes on HIGH. Stir in shrimp and green onions. Re-cover and cook on **ORIENTAL (Shrimp Oriental)**. Stir after the time appears in the Display Window. Let stand, covered, 5 minutes.

Yield: 4 servings

ORIENTAL - Oriental Spareribs

2 pounds pork sparribs, cut into 1 rib portions

SAUCE

1/2 cup soy sauce
1/3 cup honey
1/4 cup green onion, finely chopped
1/2 - 1 tablespoon fresh ginger, finely chopped
1 tablespoon rice wine vinegar
1/4 teaspoon crushed red pepper
1 clove garlic, finely chopped.

Arrange ribs in 2 1/2 quart shallow oval casserole dish. Combine sauce ingredients. Brush ribs with 1/2 of sauce. Cover with plastic wrap.

Cook on **ORIENTAL (Oriental Spareribs)**.

After time appears in Display Window, turn ribs over and brush on remaining sauce. Re-cover and press **Start**. Let stand 5 minutes before serving.

Yield: 20 appetizers

Food Characteristics

Bone and Fat

Both bone and fat affect cooking. Bones may cause irregular cooking. Meat next to the tips of bones may overcook while meat positioned under a large bone, such as a ham bone, may be undercooked. Large amounts of fat absorb microwave energy and the meat next to these areas may overcook.

Density

Porous, airy foods such as breads, cakes or rolls take less time to cook than heavy, dense foods such as potatoes and roasts. When reheating donuts or other foods with different centers be very careful. Certain foods have centers made with sugar, water or fat and these centers attract microwaves (For ex., jelly donuts). When a jelly donut is heated, the jelly can become extremely hot while the exterior remains warm to the touch. This could result in a burn if the food is not allowed to cool properly in the center.

Quantity

Two potatoes take longer to cook than one potato. As the quantity of the food increases so does the cooking time. When cooking small amounts of food such as one or two potatoes, do not leave oven unattended. The moisture content in the food may decrease and a fire could result.

Shape

Uniform sizes heat more evenly. The thin end of a drumstick will cook more quickly than the meaty end. To compensate for irregular shapes, place thin parts toward the center of the dish and thick pieces toward the edge.

Size

Thin pieces cook more quickly than thick pieces.

Starting Temperature

Foods that are room temperature take less time to cook than if they are chilled or refrigerated or frozen.

Cooking Techniques

Piercing

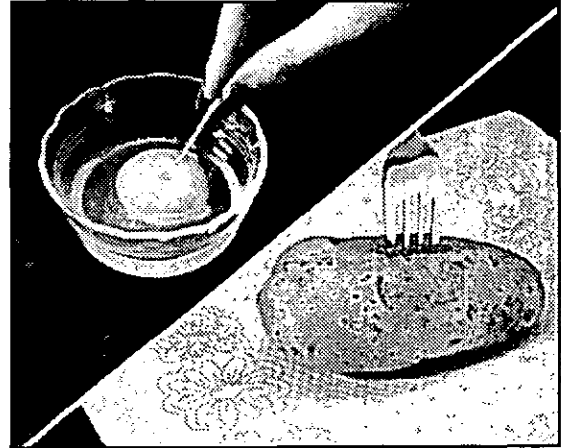

Foods with skins or membranes must be pierced, scored or have a strip of skin peeled before cooking to allow steam to escape. Pierce whole egg yolks and whites, clams, oysters, chicken livers, whole potatoes and whole vegetables. Whole apples or new potatoes should have a 1-inch strip of skin peeled before cooking. Score sausage and frankfurters.

Browning



Foods will not have the same brown appearance as conventionally cooked foods or these foods which are cooked utilizing the browning feature. Meats and poultry may be coated with browning sauce, Worcestershire sauce, barbecue sauce or shake-on browning sauce. To use, combine browning sauce with melted butter or margarine; brush on before cooking.

For quick breads or muffins brown sugar can be used in the recipe in place of granulated sugar, or the surface can be sprinkled with dark spices before baking.

Cooking Techniques

Spacing

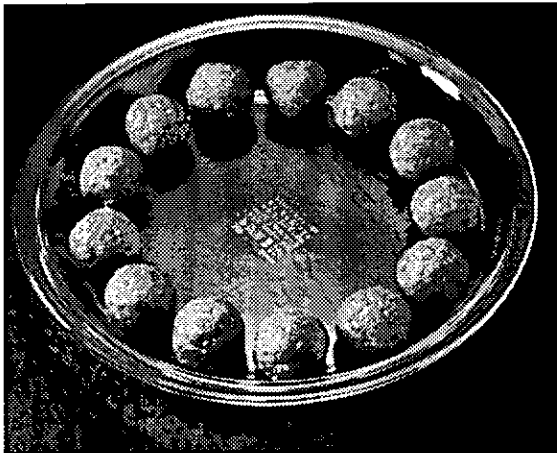

Individual foods, such as baked potatoes, cupcakes and appetizers, will cook more evenly if placed in the oven equal distances apart. When possible, arrange foods in a circular pattern.

Covering

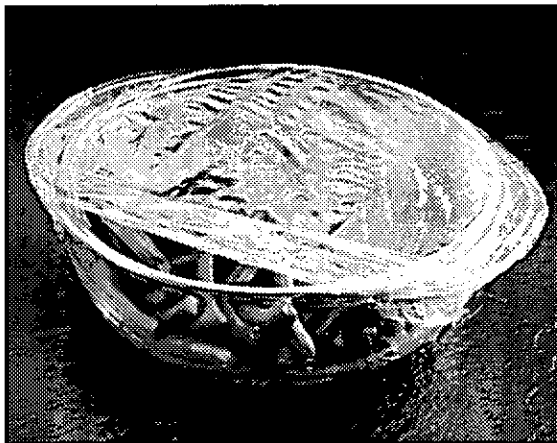

As with conventional cooking, moisture evaporates during microwave cooking. Casserole lids or plastic wrap are used for a tighter seal. When using plastic wrap, vent the plastic wrap by folding back part of the plastic wrap from the edge of the dish to allow steam to escape. Loosen or remove plastic wrap as recipe directs for stand time. When removing plastic wrap covers, as well as any glass lids, be careful to remove them away from you to avoid steam burns. Various degrees of moisture retention are also obtained by using wax paper or paper towels. However, unless specified, a recipe is cooked uncovered.

Shielding

Thin areas of meat and poultry cook more quickly than meaty portions. To prevent overcooking, these thin areas can be shielded with strips of aluminum foil. Wooden toothpicks may be used to hold the foil in place.

Timing

A range in cooking time is given in each recipe. The time range compensates for the uncontrollable differences in food shapes, starting temperature and regional preferences. Always cook food for the minimum cooking time given in the recipe and check for doneness. If the food is undercooked, continue cooking. It is easier to add time to an undercooked product. Once the food is overcooked, nothing can be done.

Stirring

Stirring is usually necessary during microwave cooking. We have noted when stirring is helpful, using the words once, twice, frequently or occasionally to describe the amount of stirring necessary. Always bring the cooked outside edges toward the center and the less cooked center portions toward the outside of the dish.

Rearranging

Rearrange small items such as chicken pieces, shrimp, hamburger patties or pork chops. Rearrange pieces from the edge to the center and pieces from the center to the edge of the dish.

Turning

It is not possible to stir some foods to redistribute the heat. At times microwave energy will concentrate in one area of a food. To help insure even cooking, these foods need to be turned. Turn over large foods, such as roasts or turkeys, halfway through cooking.

Stand Time

Most foods will continue to cook by conduction after the microwave oven is turned off. In meat cookery, the internal temperature will rise 5°F to 15°F (3°C to 8°C) if allowed to stand, tented with foil, for 10 to 15 minutes. Casseroles and vegetables need a shorter amount of standing time, but this standing time is necessary to allow foods to complete cooking in the center without overcooking on the edges.

Testing for Doneness

The same tests for doneness used in conventional cooking may be used for microwave cooking. Meat is done when fork-tender or splits at fibers. Chicken is done when juices are clear yellow and drumstick moves freely. Fish is done when it flakes and is opaque.

Meats

Directions for Roasting Meats

Tender cuts, such as beef and lamb roasts should be covered with wax paper to prevent spattering. For pork roasts or hams, cover with plastic wrap or place in an oven cooking bag.



Less tender cuts, such as pot roasts, should be cooked in liquid. Use 1 cup of liquid such as soup or broth per pound of meat. Use an oven cooking bag or covered casserole. Select a covered casserole deep enough so that the meat does not touch the lid.

TO COOK BY TIME:

Multiply the weight of the roast by the minimum recommended minutes per pound. Program Power and Time.

TO COOK BY SENSOR COOKING:

Place meat according to "Special Instructions" below. Cover with plastic wrap. Turn Pork Roast fat-side up halfway through cooking time.

1) 	PRESS once = bacon (see pg. 17) twice = chicken pieces 3 times = whole chicken 4 times = PORK 5 times = Ground meat
2)  (optional)	SELECT DONENESS once = more twice = less
3) 	PRESS

Meat Roasting Chart for Sensor & Time Cooking

MEAT	SENSOR COOKING CATEGORY	POWER & TIME COOKING [time in min/lb. (450 g)]		TEMP. AFTER COOKING	SPECIAL INSTRUCTIONS
BEEF ROASTS [2½ to 4 Lb. (1.2 to 2 kg)] Rib/Boneless Rib/Top Sirloin Rare Medium Well Rump, Eye of round (High Quality) Rare Medium Well	— — — — —	MEDIUM MEDIUM MEDIUM	9 to 11 12 to 14 14½ to 16½ 9 to 12 11 to 13 14 to 17	130°F (55°C) 140°F (60°C) 160°F (70°C) 130°F (55°C) 140°F (60°C) 160°F (70°C)	Place roast fat-side up. Cover roast with plastic wrap.
BEEF POT ROAST [2½ to 3½ Lb. (1.2 to 1.7 kg)] Chuck, Rump	—	MEDIUM LOW	30 to 35	—	Cover meat with liquid. Turn meat over half of cooking time.
PORK ROASTS [2½ to 4 Lb. (1.2 to 2 kg)] Bone-in Boneless	PORK PORK	MEDIUM MEDIUM	15 to 18 15 to 18	170°F (77°C) 170°F (77°C)	Place roast fat-side down. Cover pork with plastic wrap. Turn over halfway through cooking time.
HAM (fully cooked)* Canned [3 Lb. (1.5 kg)] Butt [8 Lb. (4 kg)] Shank [8 Lb. (4 kg)] Slice, 1-inch (2.5 cm) thick [1Lb (500 g)]	— — — —	MEDIUM MEDIUM MEDIUM HIGH	8 to 12 13 to 15 13 to 15 5 to 8	140°F (60°C) 140°F (60°C) 140°F (60°C) —	Place ham fat-side up. Cover ham with plastic wrap, except slice.
LAMB ROASTS [2½ to 4 lb. (1.2 to 2 kg)] Bone-in Medium Well Boneless Medium Well	— — — — —	MEDIUM MEDIUM MEDIUM MEDIUM	8½ to 13 11 to 16 8 to 11 10 to 15	140°F (60°C) 160°F (70°C) 140°F (60°C) 160°F (70°C)	Place fat-side up. Cover with wax paper.

* The recommended maximum weight will vary according to the cavity size of your microwave oven model and the shape of meat.

Meats

Directions for Convenience Meats

Pierce sausage links with fork and score frankfurters before cooking.

Arrange food in a single layer in dish. Cover with wax paper to prevent spatter. Bacon may be placed on a microwave-safe dish. Cook according to time given in chart.

Let stand according to recommended time in chart.

Convenience Meats Chart

MEAT	AMOUNT	POWER	APPROX. COOKING TIME (in minutes)	STAND TIME (in minutes)
Bacon, Slices	2 3 4	HIGH	1 to 2 2 to 2½ 2½ to 3	1
Canadian Bacon, Slices [1 oz. (30 g)]	2 4 6	MEDIUM-HIGH	½ to ¾ 1 to 2 3 to 4	1
Frankfurters, scored	2 4	HIGH	2 to 3 3 to 4	3
Ham, Slices [about 2 oz. (60 g) ea.]	2 4	HIGH	1½ to 2½ 2½ to 3½	2
Hamburgers, well [4 oz. (120 g) ea.]	1 2 4	HIGH	2 to 3 3 to 4 4½ to 5½	2
Lamb Chops, shoulder, ¾-inch (2 cm) thick	2 (about ½ lb.) 4 (about 1 lb.)	MEDIUM-HIGH	5½ to 7 10½ to 12	3
Pork Chops, rib or loin, ½-inch (1 cm) thick	2 (about ½ lb.) 4 (about 1 lb.)	MEDIUM-HIGH	4½ to 5½ 8 to 10	3
Sausage Links, frozen [precooked, brown and serve]	2 4 8	HIGH	1 to 2½ 1½ to 2½ 3 to 4	2
Sausage Links, fresh [2 to 3 oz. (60 to 90 g) ea.]	2 4 8	HIGH	4 to 6 6 to 8 8 to 10	3

Poultry

Directions for Roasting Poultry

Season as desired, but salt only after cooking.

Browning sauce mixed with equal parts of butter will enhance appearance. Poultry may be stuffed or unstuffed. Tie legs together with cotton string. Whole chicken should be placed breast-side down on a microwave roasting rack set in a shallow casserole dish. Cover with plastic wrap.

During cooking it may be necessary to shield legs, wings and breast bone to prevent overcooking. Wooden toothpicks can be used to hold foil in place.

If large amount of juice accumulates in the bottom of the dish, drain juices. Reserve for making gravy.

After cooking, check the temperature of large chickens and turkeys with a meat thermometer. Check the temperature in both thigh muscles. If the thermometer touches bone, the reading may be inaccurate.

DO NOT use a conventional thermometer in the oven when cooking be microwave. Use only a microwave-safe thermometer.

To Cook Chicken Parts:

Arrange pieces skin-side up, with meatier portions toward edge of dish. Cover with plastic wrap. Poultry is cooked when juices are clear. If there is a slight pink color in the juice, return poultry parts to the oven and cook one or two minutes longer.

or

Cook by **SENSOR**.

Press:

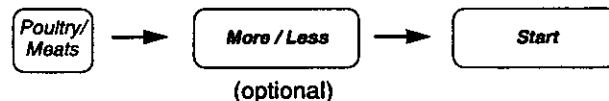

To Cook Whole Poultry:

Use the recommended power level. Use the recommended minutes per pound to calculate the time.

or

Cook by **SENSOR**

Press:

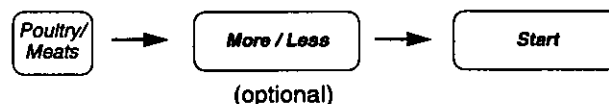

Poultry Chart for Sensor & Time Cooking

POULTRY	SENSOR COOKING CATEGORY	MANUAL COOKING POWER & TIME [time - min/lb. (450 g)]	TEMP. AFTER COOKING	SPECIAL INSTRUCTIONS
Cornish Hens, whole [1 to 1½ lb. (500 to 700 g) ea.]	WHOLE CHICKEN	Medium 17 min./lb.	180°F–190°F (80°C–90°C)	Place breast-side up. Stand time 10 minutes.
Chicken parts [up to 4 lb. (2 kg)]	CHICKEN PIECES	Medium-High 10 - 11 min./lb.	180°F–190°F (80°C–90°C)	Place skin-side up. Cover with plastic wrap. Stand time 5 minutes.
Chickens, whole [up to 6 lb (3 kg)]	WHOLE CHICKEN	Medium-High 11 - 13 min./lb.	180°F–190°F (80°C–90°C)	Place breast-side down. Cover with plastic wrap. Halfway through cooking, turn over. Stand time 10 minutes.
Turkey Breast (about 12 oz.)	WHOLE CHICKEN	Medium 12 - 14 min./lb.	180°F–190°F (80°C–90°C)	Place breast-side up. Stand time 10 minutes.
Turkey, parts	WHOLE CHICKEN	Medium 12 to 14	180°F–190°F (80°C–90°C)	Stand time 10 minutes.

Fish and Seafood

Directions for Preparing Fish and Seafood

Use fresh or defrosted clean fish. Arrange fish in a single layer in dish. For best results, avoid overlapping edges as this will prevent fish from cooking evenly.

Place thicker sections toward edge of the dish. (i.e., tail sections toward center).



TO COOK BY TIME: Arrange shrimp and scallops in single layer in dish. Cook on the recommended power level and minimum time in the chart. Rearrange or stir shrimp or scallops halfway through cooking.

Test for doneness before adding extra cooking time. The color of seafood and fish should be opaque and the fish should flake easily when tested with a fork. If undercooked, return to oven and cook 15 to 30 seconds longer at recommended power level.

After cooking, let stand, covered, 3 to 5 minutes before serving. Stand time allows the internal temperature to equalize throughout the food and thereby completes the cooking process.

TO COOK BY SENSOR COOKING:

Cover dish loosely, but completely with plastic wrap.

1) 	PRESS once = FISH FILLETS twice = SHELLFISH
2)  (optional)	SELECT DONENESS once = more twice = less
3) 	PRESS

Stir shrimp or scallops when time appears on the screen. Let stand, covered, 5 minutes.

Fish and Seafood Chart for Sensor & Time Cooking

FISH OR SEAFOOD	SENSOR COOKING		TIME COOKING		
	AMOUNT	CATEGORY	AMOUNT	MANUAL POWER SETTING	APPROX. COOKING TIME (in minutes)
Fish Fillets	½ to 2 lb. (225 g to 1 kg)	FISH FILLETS	1 lb. (450 g)	HIGH	5 to 7½
Fish Steaks [1-inch (2.5 cm) thick]	—	—	1 lb. (450 g)	MEDIUM-HIGH	5½ to 7
Scallops (sea)	½ to 2 lb. (225 g to 1 kg)	SHELLFISH	1 lb. (450 g)	MEDIUM-HIGH	5 to 6
Shrimp, medium size (shelled and cleaned)	½ to 2 lb. (225 g to 1 kg)	SHELLFISH	1 lb. (450 g)	MEDIUM-HIGH	5 to 6
Whole fish, cleaned (stuffed or unstuffed)	—	—	1 to 1½ lb. (450 g–700 g)	HIGH	5 to 7

Casseroles

Directions for Preparing Casseroles

Prepare casseroles and stews according to recipe directions. Stew meats are not browned before cooking. Omit any oil or fat and flour used for browning. Fresh and firm vegetables such as potatoes, carrots, rutabagas and beans are added at the beginning of cooking. Frozen vegetables and fresh vegetables with soft texture such as zucchini, tomatoes or mushrooms are added during the last 30 minutes of cooking. Defrosted frozen vegetables or canned vegetables are added with the thickener. Place covered microwave-safe dish in oven.

TO COOK BY TIME: Prepare casseroles or stew by microwaving at lower power levels. **MEDIUM** and **MEDIUM-LOW** power levels allows flavors to blend and less tender cuts of meat to become tender.

Use our recipes in the **Panasonic Cooking Guide** as a guideline for adapting your favorite recipes (see page 33).

Vegetables

To Cook Fresh Vegetables

Weights given in the chart are weights after peeling, trimming, etc. Prepare vegetables for cooking; cut slice or trim as directed in chart. Cook vegetables in covered casserole dish, except for whole, unpeeled vegetables.

Whole, unpeeled vegetables, such as potatoes or eggplant, should be pierced before cooking and arranged on microwave-safe dish in the oven. Arrange potatoes in a circular pattern on the dish.

TO COOK BY TIME: Cook according to the time recommended in the chart. Two-thirds of the way through cooking, stir, rearrange, and/or turn vegetables over.

TO COOK BY SENSOR (GENIUS): Select category. When time appears in the Display Window, stir vegetables. After cooking, stir vegetables. Let stand, covered, 3 - 5 minutes.

To Cook Frozen Vegetables

Empty package of vegetables into glass container. Add 2 tablespoons of water. Cover dish with lid or with plastic wrap. Cook on **Frozen Vegetables**.

For frozen vegetables in a pouch, pierce a hole in the pouch, place in a casserole dish, and cook on **Frozen Vegetables**. After cooking, stir and let stand, covered, 3 minutes before serving.

DO NOT cook frozen vegetables which contain any type of butter or sauce with a SENSOR COOK PAD.

Never leave oven unattended when heating small amounts of foods such as one or two potatoes. Potatoes may catch fire if overcooked and cause severe damage to the oven and its surroundings.

Vegetable Chart - Manual and Sensor Cooking

Vegetable	Amount	Water	Manual Cooking		Sensor Cooking Category (Any Amount)
			Power	Time (Mins.)	
Artichokes, 6 to 8 oz. ea., wrap in plastic wrap or place in covered dish.	1 2	2 tbsp. ¼ cup	Med. High	6 - 8	Fresh Vegetables
Asparagus, 6-in spears	½ lb. (225 g)	2 tbsp.	High	3½ - 4½	Fresh Vegetables
Beans, green/wax, cut into ½ in. pieces.	1 lb. (450 g)	¼ cup	Med. High	9 - 11	Potato
Beets	1 lb. (450 g)	½ cup	High	17 - 19	Potato
Broccoli, Flowerets	1 lb. (450 g)	¼ cup or less	High	5½ - 6½	Fresh Vegetables
Brussels Sprouts	1 tub 10 oz. (300 g)	¼ cup	High	5½ - 6½	Potato
Cabbage, wedges	1 lb. (450 g)	¼ cup	High	7 - 9	Fresh Vegetables
Carrots, sliced ½ in. thick medium soft al dente	1 lb. (450 g)	¼ cup	High	7 - 9	Fresh Vegetables
Cauliflower, flowerets, whole	1 lb. (450 g)	¼ cup	High	7 - 9	Fresh Vegetables
Corn, fresh on the cob (in husk) cook uncovered	1 ear 2 ears	none	High High	3 - 4 5 - 6	Fresh Vegetables
Eggplant, (fresh cubed, or sliced)	1 lb. (450 g)	¼ cup	Med. High	6 - 8	Fresh Vegetables
Spinach, leaf	1 lb. (450 g)	2 tbsp.	High	6 - 7	Fresh Vegetables
Okra	½ lb. (225 g)	none	High	3½ - 4½	Fresh Vegetables
Potatoes, 6 to 8 oz. each Cook uncovered, turn over halfway through cooking time. Pierce skin several times with fork before cooking	1 2 3 4	none	High	4 - 5 7 - 8 10 - 11 12 - 13	Potato
Squash, Summer, sliced ½ in. thick (yellow, zucchini, etc.)	1 lb. (450 g)	none	High	7 - 8	Fresh Vegetables
Squash, Winter, Cut in half, scoop out seeds, wrap in plastic wrap.	1 lb. (450 g)	none	Med. High	6 - 7	Potato
Turnips	1 lb. (450 g)	¼ cup	High	9 - 11	Potato
Rutabaga	1 lb. (450 g)	¼ cup	High	13 - 15	Potato

Pasta, Rice and Cereal

ITEM	CONTAINER	AMOUNT OF HOT WATER	SENSOR COOKING CATEGORY	MANUAL SETTINGS		STAND TIME (In min.)	SPECIAL INSTRUCTIONS
				POWER	TIME		
PASTA Egg Noodles medium width (8 oz.)	3-qt. casserole	1½ quarts	PASTA	HIGH	7 - 9	3	Add 1 teaspoon oil and 1 teaspoon salt to hot water. For sensor cooking: Add pasta, cook uncovered. For manual cooking: Cover and bring water to boil (HIGH for 10 - 15 minutes). Stir in pasta. Cook, covered; stir occasionally. Let stand, covered. Pasta that is to be added to a casserole should be slightly undercooked.
Specialty Noodle (8 oz.)	3-qt. casserole	1½ quarts		HIGH	8 - 12	3	
Spaghetti or Fusilli (8 oz. broken)	3-qt. casserole	2 quarts		HIGH	12 - 14	3	
Frozen Tortellini (16 oz.)	3-qt. casserole	1½ quarts		HIGH	7 - 9	3	
RICE Flavored Rice Mix (4.4 to 7.5 oz.)	2-qt. casserole	as pkg. directs	RICE	MEDIUM	15 - 30 or as pkg. directs	10	For sensor cooking: Combine all ingredients in cold water. Cook covered. Stir & let stand covered. For manual cooking: For long grain rice, combine all ingredients, cook covered. Stir after 2 beeps. Let stand covered. For others, cover and heat water to a boil at HIGH (4 - 7 minutes).
Long Grain (1 cup)	2-qt. casserole	2 cups		MEDIUM -LOW	14 - 18	10	
Short Grain (1 cup) (Arborio)	2-qt. casserole	2 cups		MEDIUM -LOW	10 - 12	10	
CEREAL Cream of Wheat (Reg.) 1 serving (½ tbsp.)	1-qt. glass bowl	¾ cup	_____	HIGH	2 - 4	1	Stir cereal into water. Stir frequently. Cook uncovered. Stir once before stand time.
2 servings (⅓ cup)	1½-qt. glass bowl	1½ cups		HIGH	3 - 4	1	
Farina 1 serving (3 tbsp.)	1-qt. glass bowl	1 cup	_____	HIGH	2 - 3	1	Cover and heat hot water to a boil at HIGH (3 to 6 min.) Slowly add cereal; stirring frequently. Cook uncovered. Stir once before stand time.
2 servings (6 tbsp.)	1½-qt. glass bowl	2 cups		HIGH	3 - 5	1	
Oatmeal 1 serving (⅓ cup)	individual dish	½ cup	_____	HIGH	1 - 2	1	Combine water and cereal as box directs.. Cook uncovered. Stir once before stand time.
2 servings (⅔ cup)	1½-qt bowl	1½ cup		HIGH	3 - 4	1	
4 servings (1⅓ cup)	2-qt. bowl	3 cups		HIGH	5 - 6	2	
Wheat Bran Cereal 1 serving (¼ cup)	individual dish	¾ cup	_____	HIGH	3 - 4	1	
2 servings (½ cup)	1½-qt. bowl	1½ cups		HIGH	6 - 7	1	
4 servings (1 cup)	2-qt. bowl	3 cups		HIGH	7 - 8	2	

Quick Breads and Cakes

Layer cakes must be baked **one layer at a time**, or the entire cake mix may be baked in a 16-cup fluted tube dish. Prepare batter according to package, chart or recipe directions.

Use dishes recommended in chart or in recipes. Glass dishes allow the bottom of the cakes to be checked for doneness. When the product is removed from the oven, visually check bottom.

If cake is to be inverted or removed from dish, such as layer cakes or upside-down cake, grease sides of dish and line bottom of 8" or 9" round or square dish with wax paper.

If cake is to be served directly from the dish, grease bottom of dish. Never flour cake dishes, fluted tube dishes or muffin pans.

Cook second layer of 8" or 9" round or square cake immediately after the first. The remaining batter can be used for cupcakes.

Check during cooking. Different brands vary in ingredients and density of batter; cooking times may be slightly different than those given in chart.

After cooking:

Test for doneness. Check to make sure edges of cake are dry and have begun to pull away from sides of dish, and toothpick inserted near center comes out clean.

Let stand, uncovered, on a flat surface for 10 to 15 minutes. Stand time is important to allow cakes and cupcakes to finish baking. Cakes and breads that are to be inverted should be loosened from the sides of the dish. Carefully turn out of dish. Remove wax paper from bottom of cake. Store, covered, until ready to serve.

For best results, it is recommended to follow microwave cooking instructions issued by the individual cake mix manufacturers. For best results, always undercook.

ITEM	AMOUNT OF BATTER	PREPARATION/ DISH SIZE	FIRST STAGE	SECOND STAGE	SPECIAL INSTRUCTIONS	STAND TIME
Quick Bread (14 to 17 oz.)	All batter	Line bottom of 8½" x 4½" x 2½" loaf dish with wax paper.	MEDIUM-LOW 7 - 9 min.	HIGH 4½ - 5½ min.	Shield each end with a 3" strip of foil. Mold foil around handle.	15 min. uncovered
Cornbread (7 or 8 oz.)	All batter	Grease 8" or 9" round or square dish.	MEDIUM-HIGH 3½ - 6 min.	—	Cover with wax paper.	10 min. uncovered
Gingerbread (14 oz.)	All batter	8" square dish	HIGH 8 - 12 min.	—	Shield each corner with a piece of foil. Place dish on a microwave-safe inverted pie plate.	15 min. uncovered
Muffins (Cook 6 at a time)	Fill ½ full	6-cup muffin pan lined with paper baking cups	MEDIUM 2½ - 5 min.	—	—	5 min. uncovered
Cake Mix (18 to 20¼ oz.)	2¼ cups	Wax paper-lined 8" or 9" round or square glass baking dish	MEDIUM-LOW 6 - 8 min.	HIGH 3 - 4½ min.	Place dish on microwave-safe inverted pie plate Cover with wax paper.	10 min. uncovered
Cake Mix (18 to 20¼ oz.)	Prepare batter according to package directions. Pour all batter into pan.	Generously grease 16-cup fluted tube pan	MEDIUM-LOW 8 - 10 min.	HIGH 6 - 11 min.	Cover pan with wax paper.	—
Cupcakes	2 rounded tablespoons batter per cupcake. Fill paper baking cups ½ full.	Line microwave muffin pan with paper baking cups. 2 4 6	MEDIUM (in minutes)	— 1¾ - 2 2 - 2½ 3½ - 4½	Cover with wax paper.	5 min. uncovered

Eggs and Cheese

SCRAMBLED EGGS

Beat eggs, 1 tablespoon milk and dash of salt for each egg. Pour into greased glass container. Cook at **MEDIUM-HIGH** according to time in the chart. Stir two-thirds of the way through the cooking time. Stir and let stand. Eggs will continue to cook during stand time and should be slightly undercooked after cooking.

Eggs	Container	Cooking Time (in min.)	Stand Time (in min.)
1	1-cup glass measure	$\frac{3}{4}$ - $1\frac{1}{4}$	1
2	1-cup glass measure	$1\frac{1}{2}$ - 2	$1\frac{1}{2}$
4	1-quart bowl	$3\frac{1}{4}$ - $3\frac{3}{4}$	$1\frac{1}{2}$
6	$1\frac{1}{2}$ -quart bowl	$4\frac{3}{4}$ - $5\frac{1}{2}$	2

POACHED EGGS

Place $1\frac{1}{2}$ cups hot water and a dash of vinegar and salt in 2-quart casserole and heat at **HIGH** 5 to 7 minutes, or until water boils. Break egg(s) into boiling water and with toothpick pierce egg yolk twice and egg white several times. Cook at **MEDIUM-HIGH** according to the time given in the chart. Let stand. Eggs will continue to cook during stand time and should be slightly undercooked after cooking.

Eggs	Cooking Time (in minutes)	Stand Time (in minutes)
1	$\frac{1}{2}$ - $\frac{3}{4}$	1
2	1 - $1\frac{1}{4}$	2
4	$1\frac{3}{4}$ - 2	2

Eggs cannot be hard-cooked in their shells in a microwave oven. Pressure will build up and the egg will explode.

Pies

Prepare pastry according to recipe or package directions.

If desired, for a single crust homemade pastry recipe, substitute $\frac{1}{2}$ cup whole wheat flour for $\frac{1}{2}$ cup all-purpose flour.

Microwave pie crusts are light in color. A few drops of yellow food coloring may be mixed with the liquid before adding liquid to the flour mixture. This will give the crust a pale yellow color.

Roll dough out and gently place in pie plate.

Trim edge so a $\frac{3}{4}$ -inch overhang remains. Roll overhang down to rim of pie plate. Flute edge.

Prick bottom and sides of pastry with fork.

Let pie crust rest 10 minutes. This rest time helps reduce shrinkage.

If desired, brush with dark corn syrup or molasses for sweet fillings, or brush with Worcestershire or soy sauce for savory fillings.

For frozen crust, thaw and remove from foil pie plate and place in an 8- or 9-inch glass pie plate. Place on an inverted pie plate. Heat $\frac{1}{2}$ minute, then prick crust and, if desired, brush with dark corn syrup, molasses, Worcestershire or soy sauce.

For crumb crusts, combine $\frac{1}{3}$ cup butter and $\frac{1}{4}$ cup sugar in medium bowl. Heat at **HIGH** $1\frac{1}{2}$ to 2 minutes, or until butter is melted. Stir in $1\frac{1}{4}$ cups crumbs (graham crackers, chocolate or vanilla wafers). Firmly pat into greased 9-inch pie plate.

Cook according to directions given in chart.

Visually check for doneness. Pastry crusts should be opaque. If crust is undercooked, add cooking time in 15 second increments.

Let stand until cool. Chill crumb crusts.

PIE CRUST CHART

ITEM	POWER	APPROX. COOKING TIME (in minutes)
Homemade or Mix	HIGH	3 to 4
Refrigerated	MEDIUM-HIGH	$4\frac{1}{2}$ to 5
Frozen	HIGH	2 to $2\frac{1}{2}$
Graham Cracker or Cookie Crumb	MEDIUM-HIGH	2 to $2\frac{1}{2}$

Before Requesting Service

All these things are normal:

The oven causes interference with my TV.

Some radio and TV interference might occur when you cook with the microwave oven. This interference is similar to the interference caused by small appliances such as mixers, vacuums, blow dryers, etc. It does not indicate a problem with your oven.

The oven lights dim.

When cooking with a power other than HIGH, the oven must cycle to obtain the lower power levels. The oven light will dim and clicking noises can be heard when the oven cycles.

Steam accumulates on the oven door and warm air comes from the oven vents.

During cooking, steam and warm air are given off from the food. Most of the steam and warm air are removed from the oven by the air which circulates in the oven cavity. However, some steam will condense on cooler surfaces such as the oven door. This is normal.

I accidentally ran my microwave oven without any food in it.

Running the oven empty for a short time will not damage the oven. However, we do not recommend operating the microwave oven without any food in it.

PROBLEM	POSSIBLE CAUSE	REMEDY
Oven will not turn on.	The oven is not plugged in securely.	Remove plug from outlet, wait 10 seconds and reinsert.
	Circuit breaker or fuse is tripped or blown.	Reset circuit breaker or replace fuse.
	There is a problem with the outlet.	Plug another appliance into the outlet to check if it is working.
Oven will not start cooking.	The door is not closed completely.	Close the oven door securely.
	Start Pad was not pressed after programming.	Press Start Pad.
	Another program entered already in the oven.	Press Stop/Reset Pad to cancel the previous program and program again.
	The program is not correct.	Program again according to the Operating Instructions.
The words "DEMO MODE" appear on the screen.	Stop/Reset Pad has been pressed accidentally.	Program oven again.
	DEMO MODE was activated by the Function pad.	Deactivate mode by using Function pad (p. 8 - 9).
When the oven is turning on, there is noise coming from the glass tray.	The roller ring and oven bottom are dirty.	Clean these parts according to Care of Your Oven (next page).

If it seems there is a problem with the oven, contact an authorized Servicer.

If you have any questions or it seems there is a problem with the oven, contact PANASONIC CUSTOMER CALL CENTER for assistance. 1-800-211-PANA(7262) (9 a.m. - 9 p.m., E.S.T., toll free).

Care of Your Microwave Oven

BEFORE CLEANING:

Unplug at socket of the oven. If impossible, leave oven door open to prevent oven from accidentally turning on.

AFTER CLEANING:

Be sure to replace the Roller Ring and Glass Tray in the proper position and press **Stop/Reset** Pad to clear the screen.

Inside of the oven:

Wipe with a damp cloth. Mild detergent may be used if the oven gets very dirty. The use of harsh detergent or abrasives is not recommended.

Glass Tray:

Remove and wash in warm soapy water or in a dishwasher.

Outside oven surfaces.

Clean with a damp cloth. To prevent damage to the operating parts inside the oven, water should not be allowed to seep into ventilation openings.

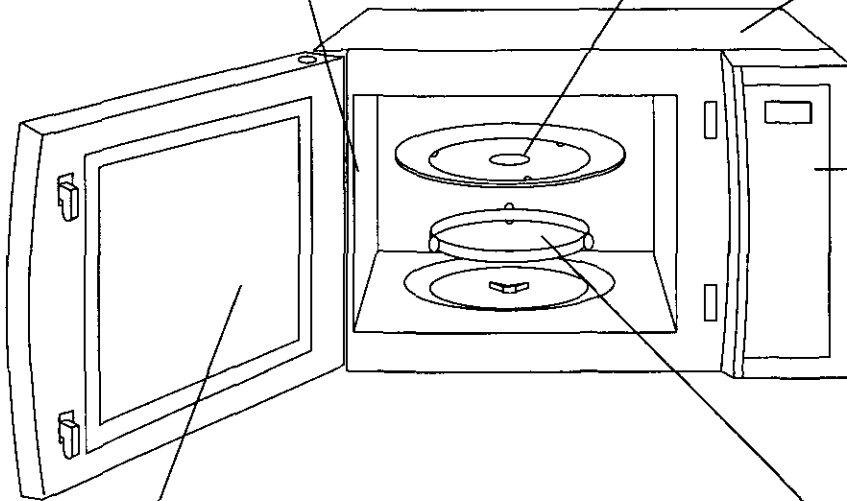

Control Panel:

* Covered with a removable protective film to prevent scratches during shipping. Small bubbles may appear under this film.

(Hint - To remove film, apply masking or clear tape to an exposed corner and pull gently.)

* If the control panel becomes wet, clean it with a soft dry cloth. Do not use harsh detergents or abrasives on the Control Panel.

Oven Door:

Wipe with a soft cloth when steam accumulates inside or around the outside of the oven door. During cooking, especially under high humidity conditions, steam is given off from the food. (Some steam will condense on cooler surfaces, such as the oven door.) This is normal.

Roller Ring and oven cavity floor:

Wipe the bottom surface of the oven with mild detergent water or window cleaner and dry. Roller Ring may be washed in mild soapy water or dishwasher. These areas should be kept clean to avoid excessive noise.

ORDER FORM

For more information regarding microwave cooking, order our new **COOKING GUIDE** (68 pages of recipes & charts).

DESCRIPTION	PART NUMBER	PRICE
Instruction / Operating Manual (this book)	B00034B1CAP	①
COOKING GUIDE	B000B8250AP	\$9.49
Glass Tray (see Care of Your Microwave Oven above)	A06015690QP (NN-S588)	\$24.31
	A06014000AP (NN-S688)	\$18.79
Roller Ring Assembly	B290D8940AP (NN-S588)	\$8.40
	B290D9330AP (NN-S688)	\$10.99

① For pricing quotes, call or write the Parts & Literature Department at the phone or address listed below. Please have your credit card information readily available.

Shipping, handling and local sales tax are not included. Price & availability subject to change. Sorry, no COD's.

PANASONIC SERVICES COMPANY
20421 84th Avenue South
Kent, WA 98032

(800) 833-9626 - Phone
(800) 237-9080 - FAX

Notes

Instrucciones de Seguridad

Su horno de microondas es un artículo para cocinar y usted debe usarlo con tanto cuidado como usa una estufa o cualquier otro artículo para cocinar.

Cuando utilice este aparato eléctrico, se deben seguir precauciones básicas de seguridad, incluyendo las siguientes:

PRECAUCION

- Para reducir el riesgo de quemaduras, descarga eléctrica, incendio, heridas a personas o exposición excesiva a energía de microondas:

1. Lea todas las instrucciones antes de usar el aparato.
2. Lea y siga las "PRECAUCIONES PARA EVITAR POSIBLE EXPOSICION EXCESIVA A ENERGIA DE MICROONDAS" específicas, que se encuentran abajo.
3. Este aparato debe ser conectado a tierra. Conecte solamente a la toma eléctrica debidamente conectada a tierra. Vea las "INSTRUCCIONES PARA CONEXION A TIERRA" que se encuentran en la página 36.
4. Instale o ubique este aparato solamente de acuerdo con las instrucciones de instalación que se encuentran en la página 36.
5. No cubra ni tape ninguna de las rendijas de este aparato.
6. No almacene o use este aparato en exteriores. No use este aparato cerca del agua - por ejemplo, cerca del fregadero de la cocina, en una base mojada, o cerca de una alberca, y similares.
7. Use este aparato sólo para los fines para los que fué hecho, tal como se describen en este manual. No use químicos o vapores corrosivos en este aparato. Este tipo de horno está específicamente diseñado para calentar o cocinar alimentos. No fué diseñado para uso industrial o de laboratorio.
8. Cuando limpie las superficies de la puerta y el horno que vienen juntas al cerrar la puerta, use solamente jabones no abrasivos o detergentes suaves aplicados con una esponja con tela suave.
9. No permita a los niños usar este aparato, a menos que sean supervisados muy de cerca por un adulto.
10. No use este aparato si tiene dañado el cordón o la clavija, si no está trabajando adecuadamente, o si ha sido dañado o se ha dejado caer.
11. No sumergir en agua el cable o la clavija.
12. Mantenga el cordón lejos de superficies calientes.
13. No deje el cordón colgando en el borde de la mesa o mostrador.
14. Este aparato debe recibir mantenimiento sólo de personal calificado. Contacte las instalaciones de servicio autorizadas más cercanas para revisión, reparación o ajuste.
15. Algunos productos, tales como los huevos completos y contenedores sellados - por ejemplo frascos de vidrio cerrados - pueden explotar y no deben ser calentados en este horno.
16. Para reducir el riesgo de incendio en la cavidad del horno:
 - (a) No sobrecocine los alimentos. Preste atención cuidadosamente al aparato. El papel, plástico u otros materiales combustibles son colocados dentro del horno para facilitar la cocción pero si no se utilizan adecuadamente esto puede producir incendio en su horno.
 - (b) Quite los sujetadores de alambre de las bolsas de papel o plástico antes de colocar la bolsa en el horno.
 - (c) Si los materiales dentro del horno se incendiaran, mantenga cerrada la puerta del horno, póngalo en posición de apagado, y desconecte la energía eléctrica, o corte el suministro eléctrico en la caja de fusibles o en el panel de control.
 - (d) No use la cavidad con propósitos de almacenaje. No deje productos de papel, utensilios de cocina o alimentos en la cavidad cuando no esté en uso.

Guardé estas instrucciones

PRECAUCIONES PARA EVITAR POSIBLE EXPOSICION EXCESIVA A ENERGIA DE MICROONDAS

- (a) No intente hacer funcionar este horno con la puerta abierta ya que esto puede resultar peligroso. Es importante no anular o bioquear los mecanismos de seguridad.
 - (1) la puerta (combada)
 - (2) bisagras y seguro de la puerta (rotos o sueltos)
 - (3) sellos de las puertas y superficies de sellado
- (b) No coloque ningún objeto entre el panel frontal del horno y la puerta, ni permita que se acumule basura o residuos de limpiadores en las superficies de sellado.
- (c) No haga funcionar el horno si está dañado, es importante que la puerta del horno abra y cierre apropiadamente:
 - (d) El horno o deberá ser ajustado o reparado por ninguna persona, excepto el personal de servicio debidamente calificado.

Instrucciones de Seguridad

Uso General

1. **NO** altere o haga ningún ajuste o reparación a la puerta, al alojamiento del panel de control, interruptores entrecruzados de seguridad o a cualquier otra parte del horno. **NO** quite el panel exterior del horno. Las reparaciones deben ser hechas solamente por personal de servicio calificado.
2. **NO** opere el horno vacío. La energía de microondas se reflejara en el interior del horno si no hay alimentos o agua para absorber la energía.
3. **NO** utilice este horno para calentar químicos o cualquier otros productos no alimenticios. **NO** limpie este horno con cualquier producto etiquetado con contenido químico corrosivo. El calentamiento de químicos corrosivos en este horno puede causar fugas de radiación.
4. **NO** seque telas, periódicos u otros materiales en el horno. Pueden incendiarse.
5. **NO** use productos de papel reciclado, ya que pueden contener impurezas que pueden causar chispas y/o incendios cuando se usen.
6. **NO** use periódicos o bolsas de papel para cocinar. Puede causar un incendio.
7. **NO** pegue, **NO** golpee el panel de control. Pueden causarse daños a los controles. Puede causar un incendio.
8. Las manoplas para tomar cosas calientes siempre deben ser utilizados cuando se retiren cosas de el horno. El calor se transfiere de los alimentos calientes a los contenedores para cocinar y de los contenedores a la Bandeja de Cristal. La Bandeja de Cristal puede estar muy caliente después de sacar los contenedores para cocinar del horno.
9. **NO** almacene materiales flamables cerca, arriba, o dentro del horno. Pueden ser riesgos de incendio.

Instrucciones Para Conexión a Tierra

Este aparato debe ser conectado a tierra. En el caso de un corto circuito, la conexión a tierra reduce el riesgo de una descarga eléctrica proporcionando una línea de escape para la corriente eléctrica. Este aparato está equipado con un cable y clavija para conexión a tierra. La clavija debe ser conectada en un tomacorriente que esté instalado adecuadamente y conectado a tierra.

PRECAUCION - El uso inapropiado de la clavija para conexión a tierra puede resultar en riesgo de descarga eléctrica.

Consulte a un electricista o a personal de servicio calificados, si las instrucciones para conectar a tierra no son completamente comprendidas o si existe duda de que el aparato está correctamente conectado a tierra. Si es necesario usar un cable de extensión, use solamente cable de extensión de tres hilos que tenga una clavija de tres entradas para conectar a tierra, y un tomacorriente de tres ranuras que acepte la clavija del aparato. El calibre marcado en el cable de extensión debe ser igual o mayor al calibre eléctrico del aparato.

Suministro Eléctrico

1. Se provee un cable de suministro eléctrico corto para reducir los riesgos resultantes de enredarse o tropezarse con un cable más largo.
2. Juegos de cable más largos o extensiones están disponibles y pueden utilizarse si se usan con cuidado.
3. Si se usa un cable más largo o extensión, (1) el calibre eléctrico marcado en el juego de cordón o extensión debe ser al menos tan grande como el calibre eléctrico del aparato, (2) el cable de extensión debe ser de tres hilos del tipo de conexión a tierra, y (3) el cordón más largo debe ser arreglado de tal forma que no caiga sobre la cubierta del mostrador o de la mesa donde pueda ser jalado por niños o tropezarse accidentalmente.

Instrucciones de Instalacion

Examine Su Horno

Desempaque el horno, quite todo el material de empaque y examine que su horno no tenga ningún daño, tales como abolladuras, seguros de la puerta rotos o resquebrajaduras en la puerta. Notifique inmediatamente a su distribuidor si el horno está dañado.



Ubicación del Horno

1. El horno debe ser colocado en una superficie plana y estable. Para su operación apropiada, el horno debe tener suficiente corriente de aire. Deje 8 cm de espacio de ambos lados del horno y 2.5 cm de espacio en la parte superior del horno.
 - a. **NO** tape las ventilas de aire. Si están tapadas durante su operación, el horno puede sobrecalentarse. Si se sobrecalienta, un dispositivo térmico de seguridad apagará el horno. El horno no operará hasta que se haya enfriado.
 - b. **NO** coloque el horno cerca de una superficie húmeda caliente, tal como un registro de gas o eléctrico.
 - c. **NO** opere el horno cuando la humedad del cuarto sea muy alta.
2. Este horno ha sido fabricado para uso en el hogar solamente.

Interferencia de Radio

1. La operación de su horno de microondas puede causar interferencia en su radio, TV o equipo similar.
2. Cuando hay interferencia, se puede reducir o eliminar tomando las siguientes medidas:
 - a. Limpie la puerta y las superficies selladoras del horno. (Vea Cuidados de Su Horno de Microondas que se encuentran en la página 53).
 - b. Ponga el radio, TV, etc. lo más lejos posible del horno de microondas.
 - c. Use una antena instalada adecuadamente para obtener una recepción de señal más fuerte.

Requerimientos de cableado

1. El horno debe estar en un circuito separado. Ningún otro aparato debe compartir el circuito con el horno. Si lo hace el fusible del circuito puede estallar, el bloqueador del circuito trabarse o la comida cocinarse más lento que en los tiempos recomendados en este manual.
2. El voltaje usado debe ser el mismo al especificado en el horno de microondas (120 V.). Usar un voltaje más alto es peligroso y puede resultar en fuego u otro accidente causando daño al horno. Usar un bajo voltaje dará como resultado una cocción más lenta. **PANASONIC** no se hace responsable por daños resultantes del uso del horno con otros voltajes que no sea el especificado.
3. El horno debe ser conectado en un enchufe a tierra de al menos 20 amp 120 volt, 60 Hz. Donde se encuentre un enchufe estándar de 2 entradas es responsabilidad y obligación del consumidor reemplazarlo por un enchufe a tierra de 3 entradas.
4. Una conexión temporal con un adaptador de 2 entradas puede ser hecha donde los CODIGOS LOCALES LO PERMITAN. A menos que el tornillo de la cubierta del enchufe esté conectado a tierra mediante el cableado de la casa, atornillar el adaptador a la tapa del enchufe **NO** pondrá a tierra el horno. Si hay alguna duda de si el tornillo de la tapa del enchufe está a tierra haga que lo cheque un electricista.

Sugerencias Útiles

Siga Esta Precauciones de Seguridad Cuando Cocine en Su Horno

1) ENLATADO CASERO / ALIMENTOS DESHIDRATADOS / PEQUEÑAS CANTIDADES DE ALIMENTOS

- No use su horno para el enlatado casero o para calentar cualquier frasco cerrado. La presión aumentará y el frasco puede explotar. Su horno no puede mantener los alimentos a la temperatura apropiada de enlatado.
- Pequeñas cantidades de alimento o alimentos con bajo contenido de humedad se pueden secar, quemar o incendiarse.
- No seque alimentos, hierbas, frutas o vegetales en su horno.

IMPORTANTE

La cocción adecuada depende del tiempo designado y del peso de los alimentos. Si usa una porción menor de la recomendada y cocina por el tiempo para la porción recomendada, puede resultar un incendio. Si ocurre un incendio, ponga el horno en posición de apagado y manténgalo cerrado. Desconecte la energía eléctrica o desconecte la caja de fusibles o el panel de control.

2) PALOMITAS DE MAÍZ

Las palomitas de maíz deben prepararse en un recipiente para palomitas de maíz adecuado para horno de microondas. Palomitas de maíz para horno de microondas que se preparan en su propio paquete también están disponibles. Siga las instrucciones del fabricante de palomitas de maíz y use una marca adecuada para la potencia de su horno de microondas. Nunca deje desatendido el horno cuando prepare palomitas de maíz.

PRECAUCIÓN

Cuando use palomitas de maíz para microondas previamente empacado siga las instrucciones recomendadas en el paquete. Revise el peso del paquete antes de usar la tecla de palomitas de maíz. Prepare el horno para el peso del paquete de palomitas de maíz (vea página 41). Si no se siguen estas instrucciones, las palomitas de maíz pueden no reventar adecuadamente o pueden encenderse y causar un incendio.

3) FREIR CON MUCHA GRASA

- No trate de freír con mucha grasa en su horno de microondas. Cocinar aceites puede estallar en flamas y puede causar daño al horno y quizá acabar en quemaduras. Los utensillos de microondas pueden no ser útiles para soportar la temperatura del aceite caliente, y podrían romperse.

4) HUEVOS

- No caliente huevos en su cáscara en el horno de microondas. La presión subirá y el huevo explotará.

5) ALIMENTOS CON PIELS NO POROSAS

- Papas, manzanas, yemas de huevo, calabazas completas y salchichas son ejemplos de alimentos con pieles no porosas. Estos tipos de alimentos deben ser perforados antes de cocinarlos en Microondas para evitar que estallen.

- Use papas frescas para hornear y cocinelas hasta que estén listas. Cocinar demasiado causa deshidratación y puede producir un incendio. Use los pesos recomendados o puede ocurrir un incendio.

6) LIQUIDOS

- Los líquidos calientes pueden hacer erupción si no se mezclan con el aire. No caliente líquidos en su horno de microondas sin agitatorios antes.

7) BANDEJA DE CRISTAL/UTENSILIOS DE COCINA/PAPEL ALUMINIO

- Los utensillos para cocinar se calientan durante la cocción en microondas. Use soportes para lo caliente, cuando saque los utensillos del horno o cuando quite tapas o cubiertas de envoltura de plástico de los utensillos de cocina, para evitar quemaduras.
- La bandeja de cristal se calentará durante la cocción. Debe permitirse que se enfríe antes de manejarla o antes de colocar productos de papel, tales como platos de papel o bolsas de palomitas de maíz para microondas, para cocinar.
- Cuando se use papel aluminio, brochetas, rejillas para calentar o utensillos hechos de metal en el horno, deje por lo menos 2,5 cm de espacio entre el material de metal y las paredes interiores del horno. Si arquea (chispea) quite el material de metal (brochetas etc.) y/o cambielo a un contenedor no metálico.
- Platos con adornos metálicos no deberan ser usados, ya que puede producirse arco eléctrico.

8) TOALLAS DE PAPEL/TELAS

- No use toallas de papel o telas que contengan fibras sintéticas en su tejido. La fibra sintética puede causar que la toalla se incendie.
- No use bolsas de papel o productos de papel reciclado en el horno de microondas.

9) BANDEJA DORADORA/BOLSAS PARA COCINAR EN HORNO

- Los bandeja doradora o asados son diseñados para cocinar en microondas solamente. Siempre siga las instrucciones dadas por el fabricante. No precaliente la bandeja doradora mas de 8 minutos.
- Si se usa una bolsa para cocinar para el microondas, prepare de acuerdo a las instrucciones del paquete. No use sujetadores de alambre para cerrar la bolsa.

10) TERMÓMETROS

- No use termómetros convencionales para alimentos en su horno. Puede producir arco.

11) GUÍA DE USO GENERAL DEL HORNO/PUERTA DEL HORNO

- No use el horno por cualquier razón que no sea la preparación de alimentos.
- No deje sin atención el horno mientras esté en uso.

Diagrama de Características

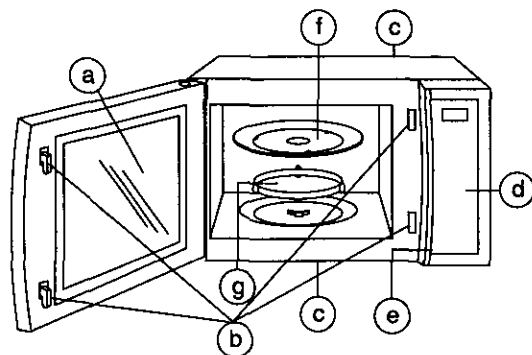

- (a) Ventana del horno (on barrera de vapor - no removerse)
- (b) Sistema de seguridad de la puerta
- (c) Orificios de ventilación del horno
- (d) Panel de control
- (e) Placa de identificación
- (f) Bandeja de cristal
- (g) Anillo del rodillo

Panel de Control

NN-S688 / NN-S588

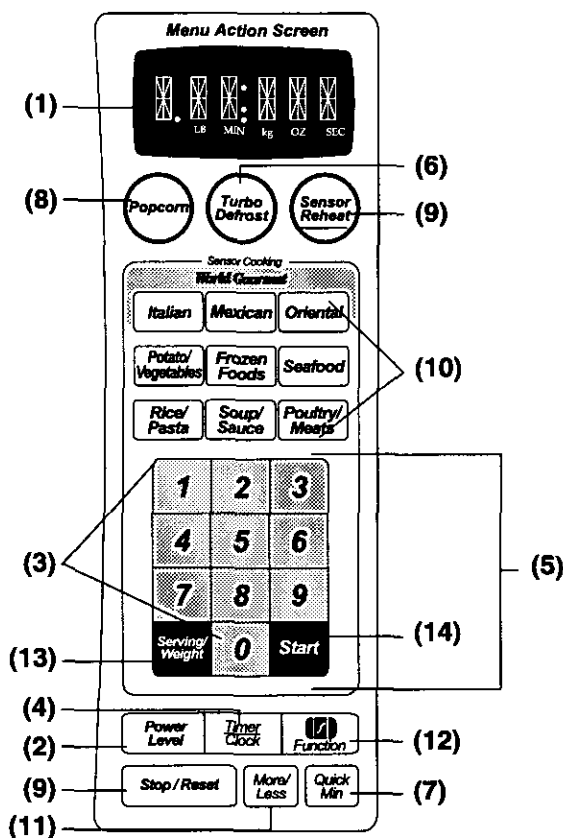

- (1) Pantalla indicadora
- (2) Pulsador de potencia
- (3) Pulsadores de numéricos
- (4) Pulsador de tiempo de espera y reloj
- (5) Pulsador de Accion de Coccion
- (6) Pulsador de descongelación turbo por peso
- (7) Pulsador de rápido en minutos
- (8) Pulsador de palomitas de maíz
- (9) Pulsador de Parar/Cancelar
- (10) Sensor de cocción automatico
- (11) Pulsador de Más/Menos
- (12) Pulsador de Funciones
- (13) Pulsador para porcions / peso
- (14) Pulsadore para Inicio

Funciones



Los pulsadores le permiten escoger el sistema en cada característica.



1	<p>OPCIÓN DE IDIOMA</p> <p>La pantalla de el horno viene en inglés, francés y español. La pantalla aparece en inglés cuando usted conecta el horno.</p> <p>1 ENGLISH → La pantalla aparece en inglés. 2 FRANCAIS → La pantalla aparece en francés. 3 ESPAÑOL → La pantalla aparece en español.</p>
2	<p>OPCIÓN Lb/Kg.</p> <p>El horno tiene medidas de peso métricas e imperiales. El horno estará en la medida de peso imperial cuando lo conecte.</p> <p>1 Lb. → El peso puede ser puesto en oz/lb. 2 KG → El peso puede ser puesto en g/kg.</p>
3	<p>VELOCIDAD DE PALABRA</p> <p>La velocidad de las palabras en la pantalla puede correr más rápido o más lento.</p> <p>1 RÁPIDO → Las palabras correrán rápido. 2 MEDIO → Las palabras correrán a su velocidad inicial. 3 LENTO → Las palabras correrán lento.</p>
4	<p>ACCIÓN DEL MENÚ ENCENDIDO/APAGADO</p> <p>La acción del menú en pantalla le ayuda a programar el horno indicando el siguiente paso a fomar por anticipado. Cuando usted se familiarize con su horno, esto puede ser apagado.</p> <p>1 ENCENDIDO (ON) → La guía aparecerá. 2 APAGADO (OFF) → La guía no aparecerá.</p>
5	<p>SEGURO PARA NIÑOS ENCENDIDO/APAGADO</p> <p>El horno tiene la característica de seguro para niños para prevenir su uso por niños.</p> <p>1 ENCENDIDO (ON) → El seguro ha sido puesto y ninguna operación será aceptada. 2 APAGADO (OFF) → El seguro ha sido cancelado.</p>
6	<p>SONIDO "BEEP" ENCENDIDO/APAGADO</p> <p>Si ustedes desea que el horno opere sin sonido "beep", puede ser eliminado.</p> <p>1 ENCENDIDO (ON) → El sonido "beep" reaparecerá. 2 APAGADO (OFF) → El sonido "beep" no se escuchará.</p>
7	<p>SONIDO "BEEP" DE RECORDATORIO ENCENDIDO/APAGADO</p> <p>Este sonido "beep" es para recordar le que retire el alimento después de que se ha completado la cocción.</p> <p>1 ENCENDIDO (ON) → El sonido "beep" de recordatorio trabajará. 2 APAGADO (OFF) → El sonido "beep" de recordatorio no trabajará.</p>
8	<p>HORARIO DE VERANO</p> <p>1 ENCENDIDO (ON) → Automáticamente ajusta el reloj una hora hacia adelante. 2 APAGADO (OFF) → Retrasa el reloj a su hora original.</p>
9	<p>RELOJ ENCENDIDO/APAGADO</p> <p>El reloj puede apagarse.</p> <p>1 ENCENDIDO (ON) → El reloj reaparecerá. 2 APAGADO (OFF) → El reloj desaparece. La hora del día no se perderá si el reloj desaparece de la pantalla.</p>
0	<p>MODO DE DEMOSTRACIÓN ENCENDIDO/APAGADO</p> <p>El modo de demostración está diseñado para su exhibición en tienda. En este modo, el horno puede ser demostrado sin poder o potencia.</p> <p>1 ENCENDIDO (ON) → El horno estará en modo de demostración. 2 APAGADO (OFF) → El horno no estará en modo de demostración.</p>

Para Seleccionar Potencia y Tiempo

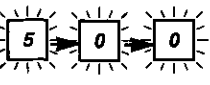
Ejem.: Nivel de potencia MEDIA por 5 minutos

1	 4 veces	• Seleccione el nivel de potencia.
2		• Seleccione el tiempo de cocción (hasta 99 min y 99 seg).
3		• Presione el pulsador START .

NOTA:

1. Al seleccionar el nivel de potencia ALTO en la primera etapa, no es necesario presionar el pulsador **Power Level**. Simplemente fije el tiempo de cocción presionando los pulsadores de Tiempo y **Start**.
2. Para cocción en 2 o 3 etapas, repetir los pasos arriba citados, antes de apretar el pulsador **Start**.
3. Pulsador **Power Level**.



Pulse	Nivel de Potencia	% Potencia
1 vez	ALTO	100%
2 veces	DESCONGELACION	30%
3 veces	MEDIANO-ALTO	70%
4 veces	MEDIO	55%
5 veces	MEDIANO-BAJO	30%
6 veces	BAJO	10%

Función Rápido en Minutos

Esta característica le permite ajustar el tiempo de cocción fácilmente en vez de usar los pulsadores numéricos o agregar tiempo de cocción extra.

Para seleccionar el tiempo de cocción:

Ejem.: Nivel de potencia ALTO por 1 minuto

1	 1 vez	• Seleccione el tiempo de cocción (hasta 10 min).
2		• Presione el pulsador Start .

NOTA:

1. Se puede usar otro nivel de potencia, selecciónelos antes de ajustar el tiempo.
2. Después de haber ajustado el tiempo por medio del pulsador **Quick Min** no podrá usar los pulsadores numéricos o vice versa.

Para Agregar Tiempo Extra:

	• Oprima para agregar tiempo de cocción (hasta 10 min) durante el cocinado. ►El tiempo de cocinado cambia para incluir el tiempo extra y continúa la cuenta regresiva en la pantalla.
--	--

NOTA:



Usted puede añadir tiempo de cocción para todos los platillos con las funciones de poder y tiempo.

Pulsador de Palomitas de Maíz

Ejem.: Para recalentar 99 g (3.5 oz.) de palomitas de maíz en bolsas especiales para microondas



NOTA:

Ponga la bolsa en el interior del horno de acuerdo con las instrucciones del fabricante.

1	 1 vez	• Seleccione el peso que se indica en la bolsa de palomitas.								
		<table border="1"> <thead> <tr> <th>Presionar</th> <th>Peso</th> </tr> </thead> <tbody> <tr> <td>1 vez</td> <td>99 g (3.5 oz.)</td> </tr> <tr> <td>2 veces</td> <td>90 g (3.0 oz.)</td> </tr> <tr> <td>3 veces</td> <td>50 g (1.75 oz.)</td> </tr> </tbody> </table>	Presionar	Peso	1 vez	99 g (3.5 oz.)	2 veces	90 g (3.0 oz.)	3 veces	50 g (1.75 oz.)
Presionar	Peso									
1 vez	99 g (3.5 oz.)									
2 veces	90 g (3.0 oz.)									
3 veces	50 g (1.75 oz.)									
2		• Presione. ►El tiempo de cocinado aparece y empieza la cuenta regresiva.								

Descongelación Turbo

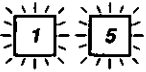
Ejem.: Para descongelar 1.5 kg. de carne

1		• Fije el peso.
2		
3		• Presione el pulsador Start .

NOTA:

La forma y el tamaño de los alimentos determinará el peso máximo que el horno puede acomodar. El peso máximo para carnes es de 1.8 kg (4 lb), aves 2.7 kg (6 lb) y pescados y mariscos 1.4 kg (3 lb).

Consejos Para Descongelar

Preparando alimentos para congelar:

1. Congele carne aves y pescado en paquetes de 1 o 2 rebanadas. Para ayudar a separar las rebanadas, coloque papel encerado entre rebanadas.
2. Envuelva en plástico resistente, bolsas o papel para congelar.
3. Remueva todo el aire posible.
4. La envoltura debe quedar justa.
5. Selle bien.



Tabla de Conversión

Siga esta tabla para convertir décimas de libra en onzas. Si un trozo de carne pesa 1.9 libras, programe 1 libra 14 onzas.

Décimas por una Libra	Onzas
0.0	0
0.1	1 - 2
0.2	3 - 4
0.3	5
0.4	6 - 7
0.5	8
0.6	9 - 10
0.7	11 - 12
0.8	13
0.9	14 - 15

Para Ajustar el Reloj

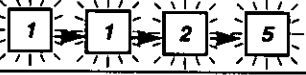
Ejem.: Para fijar 11:25 am o pm

1		• Presione el pulsador Clock dos veces. ► Los dos puntos parpadearán.
2		• Fije la hora correcta del día.
3		• Presione el pulsador Clock una vez. ► Los dos puntos dejarán de parpadear. La hora está ingresada y ubicada en las pantalla indicadora.

Técnicas Para Descongelar



1. Remueva la envoltura para prevenir retener vapor y jugo. El jugo del alimento se calentará y puede causar que la superficie o el fondo del alimento se cueza; coloque el alimento en la rejilla de el horno de microondas y deje drenar el liquido durante el descongelado .
2. Coloque la carne en un plato de tamaño apropiado. El tocino puede ser descongelado en su envoltura original.
3. Coloque la carne blanda y la pechuga hacia abajo en un plato sobre la rejilla para descongelar del horno de microondas.
4. Coloque pequeñas piezas como trozos de carne, piezas de pollo, camarones, escalopas o pescado en un plato sobre la rejilla para descongelar del horno de microondas.
5. Carnes grandes y aves enteras pueden quedar congeladas en el centro después de descongelar, deje reposar envueltos en plástico en el refrigerador (ver tabla abajo).
6. Pescados y mariscos deben quedar ligeramente congelados después de descongelar, deje reposar y remoje en agua fría por 2 o 3 minutos.
7. Piezas congeladas en rebanadas deben remojar separadamente o dejar reposar por más tiempo.

ALIMENTO	TIEMPO DE DESCONGELADO	DURANTE EL DESCONGELADO
Pescado y mariscos [arriba de 3 lb (1.5 kg)] Cangrejo Steaks de pescado Filetes de pescado Escalopas de pescado Camarón mediano Pescado entero	12 a 14 8 a 10 6 a 8 14 a 16 8 a 10 10 a 12	Rompa Voltee Voltee / Arregle Rompa / Remueva las piezas congeladas Rompa / Remueva las piezas congeladas Voltee
Carne Molida 2½ - 4 lb. (1.2 - 2 kg) Chuletas / Steak Costillas / T-bone Hígado (rebanadas finas) Puerco	8 a 10 8 a 10 8 a 10 8 a 10 4 a 6	Voltee / cubra las orillas y la superficie congelada Separa / Voltee / Arregle Voltee / Cubra Deje escurrir / Voltee / Separe las piezas Voltee
Aves Pollo entero [más de 3 lb. (1.5 kg)] Chuletas Piezas Codorniz Pechuga de pavo	6 a 10 6 a 8 8 a 10 8 a 12 8 a 12	Voltee 2 o 3 veces / Cubra partes descongeladas Voltee Separe Voltee / Arregle Voltee 2 or 3 veces

Temporizador (Timer)



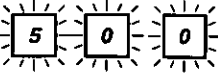

Para usar como temporizador en la cocina:

Ejem.: Para contar 5 minutos

1. 	• Presione el pulsador Timer/Clock una vez.
2. 	• Indique la cantidad de tiempo (hasta 99 min y 99 segundos).
3. 	• Presione el pulsador Start . ► El tiempo comenzará a contar en forma descendente sin que el horno esté funcionando.



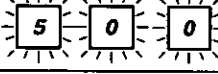

Para fijar un tiempo de espera o tiempo de reposo:

Ejem.: Después de la cocción dejar reposar el alimento durante 5 minutos.

1. Ej.  	• Seleccione el programa de cocción (ver p. 41 para instrucciones).
2. 	• Presione el pulsador de Timer/Clock una vez.
3. 	• Indique la cantidad de tiempo (hasta 99 min y 99 segundos).
4. 	• Presione el pulsador de Start . ► Después de la cocción el tiempo de reposo empezará a contar en forma descendente sin que el horno esté funcionando.

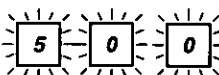
Para programar un comienzo tardío:

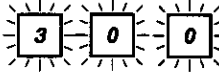
Ejem.: Para empezar a cocinar 5 minutos después

1. 	• Presione el pulsador Timer/Clock una vez.
2. 	• Indique la cantidad de tiempo que tardará en empezar el programa (hasta 99 min y 99 seg).
3. Ej.  ↓ 	• Seleccione el programa de cocción (ver p.41 para instrucciones).
4. 	• Presione el pulsador de Start . ► Cuando el tiempo demorado comience la cuenta regresiva y este haya finalizado, la cocción iniciará.



Notas:

1. Si la puerta del horno es abierta durante el tiempo de espera o cuando se usa como temporizador, el tiempo que se indica en la ventanilla continuará contando en forma regresiva.
2. El comienzo tardío no puede ser programado antes de ninguna función automática. Esto es para prevenir que el inicio de la temperatura de los alimentos se incremente antes del descongelamiento o inicio de la cocción. Un cambio en el inicio de la temperatura podría causar resultados inadecuados.

Notas

Sensor de Recalentamiento/Cocción Automática

Recalentamiento:

1		• Presione el pulsador de Sensor Reheat .
2		• Presione el pulsador Start .



Para obtener mejores resultados del Sensor de Recalentamiento, siga estas recomendaciones:

1. Todos los alimentos deben ser cocidos previamente y deben estar a temperatura o temperatura de refrigerador.
2. Los alimentos que pesen menos de 120 g y más de 680 g se deben recalentar sólo por tiempo y potencia.

NO HACER

1. Recalentar pan y productos de pastelería. Use el tiempo y potencia manual.
2. Recalentar alimentos crudos o sin cocer.
3. Usar la función de recalentamiento si el interior del horno está caliente.
4. Usar la función de recalentamiento para bebidas.
5. Usar la función de recalentamiento para alimentos congelados.

Cocción:

1	Ej. 	• Presione el pulsador de la categoría deseada hasta que aparezca el número e ítem deseado en la pantalla indicadora.
2		(Opcional)
3		• Presione el pulsador Start .

El sistema de SENSOR AUTOMATICO ("AUTO SENSOR") Trabaja detectando el vapor acumulado que despiden los alimentos en la cavidad del horno. Usted podrá cocinar y recalentar muchos de sus alimentos favoritos sin tener que seleccionar temperaturas y niveles de potencia.

ANTES de cocinar/recalentar:

(para mejores resultados por sensor, verifique lo siguiente)

1. La temperatura ambiente que rodea al horno debe ser menor de 35°C (95°F).
2. El peso de los alimentos no deberá ser menor a 120 g (4 onzas) aprox.
3. El plato giratorio de cristal y el contenedor que se va a utilizar deben estar secos.
4. Cubra los alimentos por completo con papel plástico procurando que este no quede muy adherido, o bien, colocarlo en una cacerola con tapa.

DURANTE la cocción/recalentado:

Mientras la palabra "AUTO" se muestre en la pantalla indicadora, no deberá abrirse la puerta del horno por más de 1 minuto, esto causaría resultados inadecuados en la cocción. El tiempo restante de cocción aparecerá inmediatamente en la pantalla indicadora y comenzará a contar en forma descendente. El horno puede ser abierto durante este tiempo restante para voltear, batir o añadir ingredientes.

DESPUES de la cocción/recalentado:

Todos los alimentos deben estar cubiertos durante un tiempo de 3 a 5 minutos.

Control de grado de cocción mas/menos (More/Less):

Las preferencias en el grado de cocción de los alimentos varían en cada individuo, con este pulsador usted podrá decidir qué tipo de grado de cocción prefiere en sus alimentos.

Usando este pulsador el Sensor automatico puede ser ajustado para cocinar el alimento por más o menos tiempo. Si usted está satisfecho con los resultados de cocción del programa "auto sensor", no necesitará usar el control más/menos.

Un toque: más cocido con indicador "MAS"

Dos toques: menos cocido con indicador "MENOS"

Tres toques: cocido inicial

Sensor de Cocción Automática

	CATEGORÍA	PESO	INSTRUCCIONES
Potato/ Vegetables	1 x Papas	cualquier cantidad	Abra la piel varias veces y coloque en un molde a prueba de microondas. NO cubra. De la vuelta después del sonido.
	2 x Vegetales Frescos	cualquier cantidad	Agregue agua. Cubra con la tapa o cubierta de plástico. Revuelva o reacomode después del sonido.
	3 x Vegetales Congelados	cualquier cantidad	Agregue 2 cucharadas soperas de agua. No cocine con mantequilla o salsa. Cubra con la tapa o cubierta de plástico. Revuelva o reacomode después del sonido.
Rice/Pasta	1 x Arroz	Arroz . . . Agua 1/2 taza . . . 1 taza 1 taza . . . 2 tazas 1 1/2 taza . . . 3 tazas 2 tazas . . . 3 1/2 tazas	Ponga arroz y agua caliente con 1/4 de cucharadita de sal. Cubra con la cubierta de plástico. Después del "beep", bata muchas veces. Después de cocinar bata y deje reposar de 5 a 10 minutos.
	2 x Pasta	cualquier cantidad	Ponga 1 1/2 cuartos de agua, pasta, 1 cucharada de aceite y 1 cucharadita de sal en una cacerola de 4 qt. Cubra. Después del "beep" bata ocasionalmente.
Frozen Foods	1 x Entradas Congeladas	cualquier cantidad	No use alimentos congelados en charolas selladas. Siga las instrucciones del fabricante para cubrir. Revuelva, bañe con la salsa o con el jugo después del sonido.
	2 x Platos Fuertes Congelados	cualquier cantidad	No use alimentos congelados en charolas selladas. Siga las instrucciones del fabricante para cubrir. Revuelva, si es posible, después del sonido.
Soup/ Sauce	1 x Soupe	cualquier cantidad	Vacíe la sopa dentro del contenedor que usara en el horno de microondas.
	2 x Salsa	cualquier cantidad	Cubra sin sellar con una tapa o envoltura plástica.
Seafood	1 x Filete de Pescado	230 - 680 g (1/2 - 1 1/2 lb.)	Acomode en una sola capa en el molde. Cubra con tapa o cubierta de plástico. Reacomode después del sonido.
	2 x Marisco	230 - 680 g (1/2 - 1 1/2 lb.)	Acomode en una sola capa en el molde. Cubra con tapa o cubierta de plástico. Revuelva los camarones u ostras después del sonido.
Poultry/ Meats	1 x Tocino	2, 3, 4, o 6 rebanadas	Pon las rebanadas en un plato. Tapa con toallas de papel.
	2 x Piezas de Pollo	230 g - 1 kg (1/2 - 2 lb.)	Coloque el lado de la piel hacia arriba. Cubralo con cubierta de plástico. Después del sonido, reacomódelo.
	3 x Pollo Entero	hasta 3 kg (6 lb.)	Coloque el lado de la pechuga hacia abajo. Cúbralo con cubierta de plástico. Voltee el lado de la pechuga hacia arriba después del sonido.
	4 x Cerdo	1 - 2 kg. (2 - 4 lb)	Coloque la parte de grasa hacia arriba. Cúbralo con cubierta de plástico. Voltéelo, después del sonido.
	5 x Carne Molida (No es barbacoa)	230 - 900 g (1/2 - 2 lb.)	Con las manos, hala la carne in piezas en un recipiente de vidrio. Cubra con la tapa o cubierta de plástico. Después de dos "beeps" de la microonde parará y tiempo que queda aparecerá. Revuelva la carne para que la carne queda en pedazos aun mas pequeños. El tiempo en pantalla indicadora contará contar abajo. El jugo de la carne debe ser claro. Drenar la grisa.

Cocinando Gastronomía Internacional

Tablero	Categoría	Preparación	Instruccions
ITALIANA	Pollo Cacciatore	Prepárelo siguiendo la receta de la página 49. Cúbralo con envoltura de plástico.	Después de cocinarlo, quite la cubierta y déjelo reposar durante 5 minutos.
	Lasaña Fácil	Prepárelo siguiendo la receta de la página 49. Cúbralo con envoltura de plástico.	Después de 2 beeps, aparece en la pantalla de la ventana la hora. Cheque las orillas y asegúrelas si es necesario. Recúbralo y presione Iniciar (Start). Después de cocinarlo, agregue el queso Parmesano. Cúbralo y déjelo reposar durante 5 minutos.
	Pollo Parmesano	Prepárelo siguiendo la receta de la página 49. Cúbralo con envoltura de plástico.	Después de 2 beeps, la hora aparecerá en la pantalla de la ventana. Reacomode, agregue los condimentos, recubra y presione Iniciar (Start). Después de cocinarlo agregue el queso mozzarella. Cúbralo y déjelo reposar durante 5 mins.
MEXICANA	Pollo a la Mexicana	Prepárelo siguiendo la receta de la página 50. Cúbralo con envoltura de plástico.	Después de 2 beeps, la hora aparece en la pantalla de la ventana. Voltéelo, reacomodelo y báñelo con salsa. Presione Iniciar (Start). Después de cocinarlo, agregue el queso y déjelo reposar durante 5 minutos.
	Taquitos de Pollo	Prepárelo siguiendo la receta de la página 50. Cúbralo con envoltura de plástico.	Después de 2 beeps, la hora aparece en la pantalla de la ventana. Voltéelo, reacomodelo, recúbralo y presione Iniciar (Start). Después de cocinarlo, escúrralo (si el necesario). Prepárelo para servirlo.
	Tacos con Chili	Prepare la carne siguiendo la receta de la página 50. Cúbralo con envoltura de plástico.	Después de 2 beeps, la hora aparece en la pantalla de la ventana. Revuélvalo con una cuchara grande, recúbralo y presione Iniciar (Start). Después de cocinarlo, haga los tacos.
ORIENTAL	Pollo Teriyaki	Marínelo 30 mins. antes de cocinarlo. Vea la receta de la página 51. Cubralo con una envoltura de plástico.	Después de 2 beeps, la hora aparece en la pantalla de la ventana. Voltéelo, reacomodelo y báñelo con salsa. Recúbralo. Presione Iniciar (Start). Después de cocinarlo, déjelo cubierto, reposando durante 5 mins.
	Brocheta Oriental	Prepárelo siguiendo la receta de la página 51. Cúbralo con envoltura de plástico.	Después de 2 beeps, la hora aparece en la pantalla de la ventana. Voltéelo, reacomodelo y báñelo con salsa. Recúbralo. Presione Iniciar (Start). Después de cocinarlo, déjelo cubierto, reposando durante 5 mins.
	Camaron Oriental	Prepare la salsa con la receta de la pagina 51. Cocine 2-3 mins. en ALTO (HIGH). Agregue los camarones & cebollas. Cúbralo con una envoltura de plástico. Presione Oriental . (Camaron Oriental)	Después de 2 beeps, la hora aparece en la pantalla de lan ventana. Voltéelo, reacomodelo y báñelo con salsa. Recúbralo. Presione Iniciar (Start). Después de concinarlo, dejándolo cubierto durante 5 minutos.

Recetas - Italiana

ITALIANA - Lasagna

SALSA PARA LA CARNE

1/2 libra (250 g) de carne molida
1 frasco (28 - 30 oz.) salsa para spaghetti
1/2 taza de agua

SALSA DE QUESO

1 frasco (15 oz.) de queso cottage o ricotta
1 huevo, ligeramente batido
1/2 cucharadita de sal
1 cucharadita de pimienta blanca
9 tiras de lasaña cocida (vea **Pasta**, página 29)
1/2 libra (250 g) de queso mozzarella rayado finamente
1/2 paquete de queso Parmesano

SALSA PARA LA CARNE

Desmenuce la carne molida dentro de un recipiente de vidrio o en un recipiente especial para microondas. Cocínelo en ALTO (HIGH), 1 1/2 minutos o hasta que la carne se cosa. Revuélvala una vez. Escúrrala. Mézclala con la salsa de spaghetti y agua. Cocínelo en ALTO (HIGH), 3 1/2 - 4 1/2 minutos.

SALSA DE QUESO

En otro molde, mezcle el queso ricotta, el huevo, la sal y la pimienta.

Ponga 1/4 de la salsa de carne en un molde rectangular (o oval que quepa en su horno), alternando capas con la pasta, la mezcla de queso, el queso mozzarella y la salsa de la carne formando tres capas. Cúbrelo con plástico y cocínelo en **ITALIANA (Lasaña fácil)**. Después de que la hora aparece en la pantalla indicadora, proteja las esquinas (vea la página 23 "Shielding") si es necesario. Cuando termine de cocinarse, espolvoree queso Parmesano, recúbralo. Déjelo reposar cubierto, 5 minutos antes de servir.

ITALIANA - Pollo Parmesano

1 huevo
1/4 de taza de agua
2 pechugas de pollo deshuesadas, partidas a la mitad
1 taza de pan molido tostado sazonado
1/2 taza de queso Parmesano rayado
1/4 de cucharadita de paprika
2 cucharadas de aceite
1 lata (8 oz.) de puré de tomate
o 1 taza de salsa para espagueti
Orégano
1 taza (4 oz.) de queso mozzarella desmenuzado

Bata el huevo con agua, en un mode aparte, combine el pan molido, el queso Parmesano y la paprika. Sumerja el pollo en la mezcla de pan molido, y después en la mezcla del huevo y nuevamente en la de pan molido. Cubra el fondo de un refractario cuadrado de 8 pulgadas con una cucharada de aceite. Coloque el pollo cubierto en el refractario; rocíelo con el aceite restante.

Cocínelo en **ITALIANA (Pollo Parmesano)**, cubierto con plástico. Después de que la hora aparezca en la pantalla indicadora, abra la puerta. Recomendelo y volteo el pollo, agregue puré de tomate y orégano. Recúbralo y presione Iniciar (**Start**). Después de cocinarlo, cúbralo con el queso mozzarella. Cubierto, déjelo reposar durante 5 minutos o hasta que el queso se derrita.

Cantidad: 4 porciones

ITALIANA - Pollo Cacciatore

2 libras (1 kg) de pollo en piezas
1 lata (8 oz.) de puré de tomate
1 lata (8 oz.) de paste de tomate
1 lata (4 oz.) de champiñones rebanados, escurridos
1/2 taza de cebolla picada
1 cucharada de azúcar, opcional
1/2 cucharadita de orégano
1 cucharadita de sal
1 diente de ajo, finamente picado
1/4 de cucharadita de pimienta

Coloque el pollo en un refractario oval colocando las porciones de carne hasta los extremos del refractario. Mezcle los ingredientes restantes; póngalos sobre el pollo. Cúbralo con plástico.

Cocínelo en **ITALIANA (Pollo Cacciatore)**. Después de cocinarlo, destápelo y déjelo reposar, cúbralo 5 minutos. Si lo desea, sírvalo con espagueti.

Cantidad: 4 porciones

Recetas Mexicana

MEXICAN - Tacos con Chili

- 1 libra (1/2) kg de carne finamente deshebrada
- 1 paquete (1 1/4 oz.) de mezcla sazónada para tacos
- 1/2 taza de agua
- 12 tortillas para tacos
- 1 taza de lechuga en tiras
- 2/3 de taza de jitomates picados
- 1/4 de pimienta verde (chile) o cebolla
- 1 taza (4 oz.) de queso Cheddar en tiras
o Queso Jack Monterey

Mezcle la carne molida, la mezcla sazónada y el agua en una cacerola. Cúbralo con una tapa o con plástico.

Cocínelo en **MEXICAN (Tacos con Chili)**. Después de que aparece la hora en la Pantalla Indicadora, muévelo. Recúbralo y presione Iniciar (**Start**). Después de cocinar, muévelo y déjelo reposar durante 3 minutos.

Para Finalizar:

Rellene las tortillas con 2 cucharadas con la mezcla de carne escurrida (Sugerencia: use una cuchara con ranuras). Para servirlo, póngales encima lechuga, jitomate, pimienta morón verde (chile) y queso.

MEXICAN - Pollo a la Mexicana

- 1 lata (15 oz.) salsa de tomate
- 2 a 3 cucharadas de jalapeños, finamente picados
- 2 cucharadas de cebolla picada
- 3/4 de cucharadita de chili en polvo
- 1/4 de cucharadita comino
- 1/4 de cucharadita de pimienta roja
- 2 oz. (50 g) de queso Jack Monterey en tiras, (opcional)
- 1 1/2 - 2 libras (1 kg) de piezas de pollo

Salsa

En un recipiente pequeño, mezcle la salsa de tomate, los pimientos chili, la cebolla, el chili en polvo, el comino y la pimienta roja. Coloque el pollo con la piel hacia abajo en una cacerola oval poco profunda. Vierta la salsa uniformemente sobre el pollo. Cúbralo con una envoltura de plástico.

Cocínelo en **MEXICAN (Pollo a la Mexicana)**. Después de que la hora aparezca en la Pantalla Indicadora, reacomode el pollo, voltéelo y báñelo con salsa. Recúbralo con plástico. Presione Iniciar (**Start**). Para finalizar la preparación esparza queso. Recubralo y déjelo reposar 5 minutos antes de servirlo.

MEXICAN - Taquitos de Pollo

- 2 pechugas de pollo deshuesadas.
sin piel (1 - 1 1/2 libra), partidas y aplanadas
- Chili en polvo
- Pimienta
- 2 oz. (50 g) de queso Cheddar, cortado en cuartos
- 1/4 de aceitunas verdes rebanadas
- 3/4 taza de empanizador para taco u hojuelas de maíz
- 1 lata (8 oz.) de salsa para taco

Sazone un lado de cada una de las pechugas de pollo con et chili en polvo y la pimienta. Coloque una rebanada de queso en cada pechuga. Espolvoree 1 cucharada de aceitunas en el centro. Doble las esquinas cubriendo el relleno. Asegúrelas con palillos de madera. Colóquelas con el lado que tiene la abertura hacia abajo en un refractario de 8 pulgadas. Cúbralo con envoltura de plástico.

Cocínelo en **MEXICAN (Taquitos de Pollo)**. Después de que la hora aparece en la Pantalla Indicadora, abra la puerta, reacomode, voltee el pollo y recúbralo. Presione Iniciar (**Start**). Déjelo reposar 5 minutos con su cubierta. Escurra, si es necesario. Mientras que deje el pollo reposando, caliente la salsa para tacos durante 2-3 minutos en ALTO (HIGH) o hasta que este caliente. Vierta la salsa sobre el pollo, espolvoreando las hojuelas y sívalo.

Cantidad: 4 porciones

Recetas Oriental

ORIENTAL - Pollo Teriyaki

SALSA

- 1 lata (8 oz.) de piña rebanadas con jugo de piña
- 1 diente de ajo, finamente picado
- 1/4 de taza de salsa de soya
- 2 cucharadas de azúcar morena
- 1/2 cucharadita de sal
- 1/4 cucharadita de jengibre

1 1/2 - 2 libra (750 g) de piezas de pollo

En un recipiente pequeño, mezcle todos los ingredientes de la salsa. Marine el pollo en la salsa durante 30 minutos. Coloque el pollo con el lado con piel hacia abajo en una cacerola oval poco profunda colocando las porciones de carne a lo largo del recipiente. Vierta la salsa sobre el pollo. Cúbralo con envoltura de plástico.

Cocínelo en **ORIENTAL (Pollo Teriyaki)**.

Después de que la hora aparezca en la Pantalla Indicadora recomode voltee el pollo.

Recúbralo y presione Iniciar (**Start**).

Deje reposar durante 5 minutos.

Vierta la salsa de piña sobre el pollo antes de servir.

ORIENTAL - Brocheta Oriental

2 libra (1 kg) de costillas de cerdo, cortadas en porciones de una costilla

SALSA

- 1/2 taza de salsa de soya
- 1/3 taza de miel
- 1/4 taza de cebolla, finamente picada
- 1/2 - 1 cucharada de jengibre fresco, finamente picado
- 1 cucharada de vinagre de arroz
- 1/4 cucharadita de pimienta roja en grano
- 1 diente de ajo, finamente picado

Coloque las costillas en una cacerola poca profunda. Mezcle los ingredientes de salsa. Barnice las costillas con 1/2 de la salsa. Cúbralo con plástico.

Cocínelo en **ORIENTAL (Brocheta Oriental)**. Después de que la hora aparezca en a Pantalla Indicadora, voltee las costillas y barnícelas con la salsa que queda. Recúbralo y reinicie. Deje reposar durante 5 minutos antes de servirlo.

ORIENTAL - Camaron Oriental

SALSA

- 1/2 taza de agua
- 3 cucharadas de salsa de soya
- 2 cucharadas de jerez
- 1/8 de cucharadita de salsa picante
- 1 diente de ajo, finamente picado
- 2 cucharadas de fécula de maíz
- 1 paquete (6 oz.) chícharos en vaina, descongelados y secos (vea la página 28)
- 1 lata (8 oz.) de raíces de bambú, seco
- arroz cocinado caliente, opcional (vea página 29)

1 1/4 libra (1/2 kg) de camarón gigante con cáscara, y limpio
4 cebollas, en rebanadas

En una cacerola mezcle el agua, salsa de soya, el jerez, la salsa picante y el ajo, licúe la fécula de maíz hasta que ablande. Mezcle los chícharos y las raíces de bambú. Cúbralo con una tapa o con una envoltura de plástico. Cocínelo durante 2 1/2 - 3 minutos en ALTO (HIGH). Mezcle el camarón y las cebollas.

Recúbralo y cocínela en **ORIENTAL (Camaron Oriental)**.

Muévalo después de que la hora aparezca en la Pantalla Indicadora. Déjelo reposar, cubierto durante 5 minutos.

Si lo desea, sírvalo con arroz.

Notas

Cuidados de Su Horno de Microondas

ANTES DE LIMPIAR: Apague el horno y desconecte el cable de alimentación para prevenir un encendido accidental.

Interior del horno: Limpie su horno con un paño húmedo. Puede utilizar un detergente suave si el horno está muy sucio. El uso de limpiadores abrasivos no es recomendable.

Puerta del horno: Si el vapor se acumula en el interior o alrededor de la puerta del horno, limpie con un paño suave. Esto puede suceder cuando el horno se opera en condiciones demasiado húmedas y no indica mal funcionamiento de la unidad.

Panel de controles: Limpie su panel con un paño suave, no use detergentes fuertes ni abrasivos.

Plato giratorio de cristal: Remueva el plato de cristal. Cuando esté frío y lave con agua tibia y jabonosa o en su lavadora de platos.

El anillo giratorio: Limpie el soporte del plato giratorio que se encuentra en el horno con agua jabonosa. El anillo giratorio debe ser limpiado en agua jabonosa o en su lavadora de platos. Estas partes deben estar limpias para evitar un excesivo ruido.

DESPUES DE LIMPIAR: Esté seguro de colocar el anillo giratorio y el plato de cristal en la posición correcta y presione Stop/Reset para limpiar la ventanilla indicadora.

Antes de Acudir al Servicio

Todas estas cosas son normales:

Mi horno de microondas causa interferencia con mi televisor.	En algunos radios y televisores puede ocurrir interferencia cuando usted cocine con su horno de micro ondas, Esta interferencia es similar a la interferencia causada por pequeños aparatos eléctricos como batidoras, aspiradoras, secadoras de aire, esto no indica ningún problema.
La luz del horno se atenúa.	Cuando se está cocinando con una temperatura diferente a temperatura alta (HIGH) el horno tiene que recorrer un ciclo para obtener niveles de potencia más bajos. La luz del horno se atenúa y podrá oír ruidos de "click" cuando el horno realiza su ciclo.
Se acumula vapor en la puerta del horno y aire caliente sale de las rejillas de ventilación.	Durante la cocción los alimentos despiden vapor. La mayoría de este vapor es removido por el aire que circula en la cavidad del horno, sin embargo, algo de vapor se condensará en las superficies frías tales como la puerta del horno. Esto es normal.
Accidentalmente encendió su horno de micro ondas sin ningún alimento dentro.	Operar el horno vacío por un corto tiempo no dañará el horno sin embargo no lo recomendamos.

PROBLEMA







POSIBLE CAUSA

SOLUCION

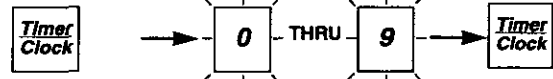
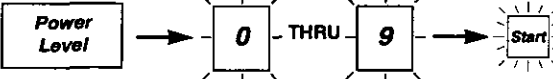
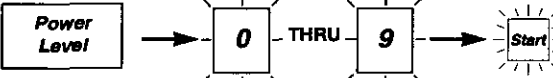
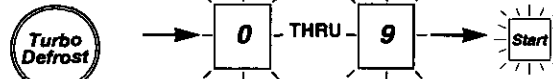
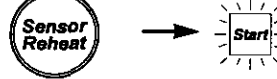
El horno no enciende.	→	¿Esta el horno conectado en forma segura?	Remueva la clavija de contacto de la toma de corriente. Espere 10 seg. Vuelva a conectar.
		El circuito general de luz o el fusible están fuera de servicio o tienen algún problema interno.	Encienda de nuevo su circuito general de luz o reemplace el fusible.
		Hay un problema en la toma de corriente.	Conecte otro aparato eléctrico para verificar su toma de corriente.
El horno no acepta mi programa.	→	La puerta del horno no está bien cerrada.	Cierre la puerta firmemente.
		Otro programa se encuentra registrado en su horno.	Presione Stop/Reset (parar/borrar) para cancelar el programa anterior y programe de nuevo.

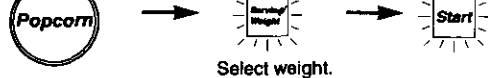
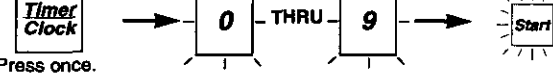
Si al parecer el problema se encuentra en su horno, consulte al centro de servicio más cercano.

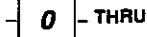
Quick Guide to Operation

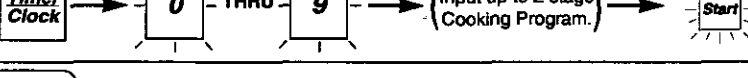
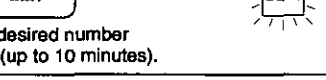
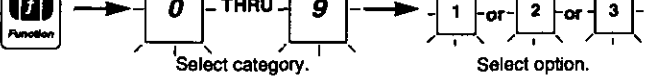
Feature	How to Operate
To Set Clock (☛ page 10)	 <p>Press twice. Enter time of day. Press once.</p>
Power and Time Setting (☛ page 10)	 <p>Select power. Set cooking time.</p>
To Defrost using Manual Defrost (☛ page 10)	 <p>Select defrost. (2 x's) Set time.</p>
"Turbo Defrost" (☛ page 12)	 <p>Enter weight.</p>
To Reheat using "Sensor Reheat" (☛ page 16)	
To Cook using "Sensor Cooking" (☛ page 16 - 21)	<p>e.g.  → </p> <p>Select desired category.</p>
To Cook using "Popcorn" (☛ page 14)	 <p>Select weight.</p>
To use as a Timer (☛ page 11)	 <p>Press once.</p>
To use to set Stand Time (☛ page 11)	<p>(Input up to 2 stage Cooking Program.) →  →  → </p>
To set Delay Start (☛ page 11)	
To Cook using "Quick Min" (☛ page 14)	 <p>Tap desired number of times (up to 10 minutes).</p>
To use "Function Pad" (☛ page 8-9)	 <p>Select category. Select option.</p>